

## PGB1 Series

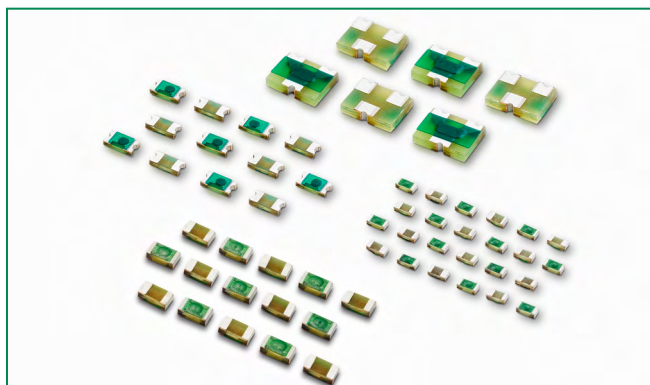

### Equivalent Circuits

#### 0402 and 0603 Devices



#### SOT23 Device

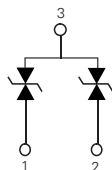

### Product Characteristics

Part Number	Lines Protected	Component Package	Available as Halogen-Free
PGB1010402	1	0402	No <sup>1</sup>
PGB1010603	1	0603	Yes
PGB102ST23	2	SOT23	Yes

### Electrical Characteristics

Specification	PGB1010402	PGB1010603	PGB102ST23	Notes
ESD Capability: IEC 61000-4-2 Contact Discharge (typical) IEC 61000-4-2 Air Discharge (maximum)	8kV 15kV	8kV 15kV	8kV 15kV	The ESD capability measured by direct and air discharge method is subject to testing equipment and conditions. Numerous factors could affect the reliability and reproducibility of the direct and air discharge test results.
Peak Voltage (typical)	1000V	500V	500V	Measured per IEC 61000-4-2 8kV Contact Discharge <sup>2</sup>
Clamping Voltage (typical)	250V	150V	150V	Measured per IEC 61000-4-2 8kV Contact Discharge <sup>2</sup> , at 25 nsec.
Rated Voltage (maximum)	12VDC	24VDC	24VDC	
Capacitance (typical)	0.04 pF	0.06 pF	0.12 pF	Measured at 250 MHz
Response Time	<1nS	<1nS	<1nS	
Leakage Current (typical)	<1nA (12 VDC)	24V	24V	
ESD Pulse Withstand	1000 pulses min	1000 pulses min	1000 pulses min	Some shifting in characteristics may occur when tested over multiple pulses at a very rapid rate

Notes: 1. PGB1 0402 product not offered as Halogen Free. See PGB2 series 0402 product instead (<http://www.littelfuse.com/series/PGB2010402.html>).  
2. Testing performed on Littelfuse test setup as described in Typical Test Setup Section on page 4 of this document.

Life Support Note:

#### Not Intended for Use in Life Support or Life Saving Applications

The products shown herein are not designed for use in life sustaining or life saving applications unless otherwise expressly indicated.

### Description

PULSE-GUARD® ESD Suppressors help protect sensitive electronic equipment against electrostatic discharge (ESD). They supplement the on-chip protection of integrated circuitry and are best suited for low-voltage, high-speed applications where low capacitance is important. Data ports utilizing such high-speed protocols as USB 2.0, IEEE1394, HDMI and DVI can benefit from this new technology.

PULSE-GUARD® suppressors use polymer composite materials to suppress fast-rising ESD transients (as specified in IEC 61000-4-2), while adding virtually no capacitance to the circuit.

### Features

- RoHS compliant, lead-free and available halogen-free
- Ultra-low capacitance
- Low leakage current
- Fast response time
- Bi-directional
- Withstands multiple ESD strikes
- Compatible with pick-and-place processes
- Available in 1000, 3000, 5000 and 10000 piece reels (EIA-RS481)

### Applications

- HDTV Hardware
- Laptop/Desktop Computer
- Network Hardware
- Computer Peripherals
- Digital Camera
- External Storage
- Set-Top Box
- Antenna

**Part Numbering System**

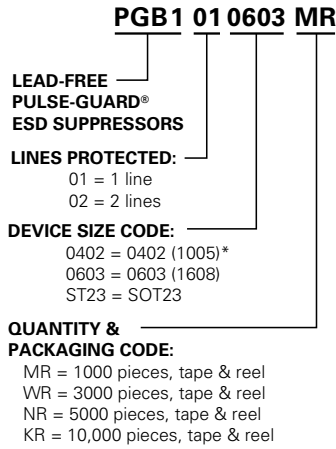

\*Note: PGB1 0402 product not available as Halogen Free item. See PGB2 0402 product instead, part number PGB2010402KRHF (<http://www.littelfuse.com/series/PGB2010402.html>).

**Typical Device Capacitance**

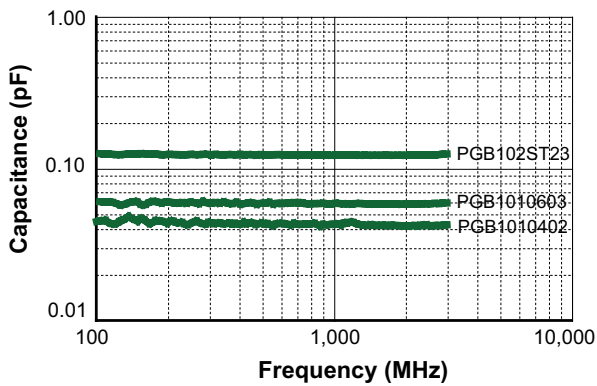

**Typical ESD Response**

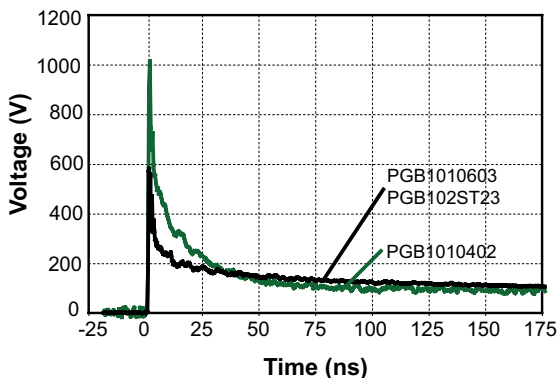

**Dimensions**

**0402 Device**

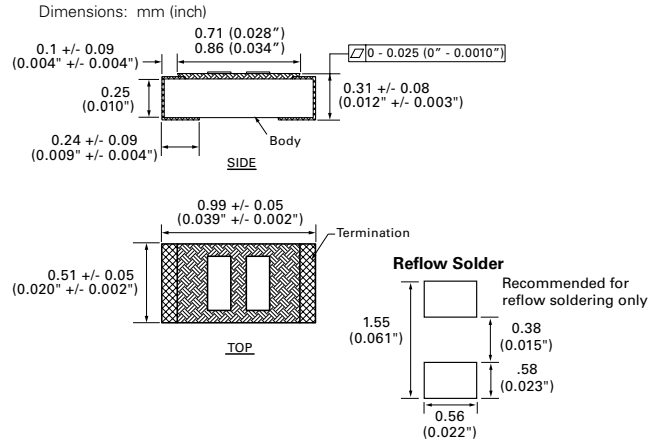

**0603 Device**

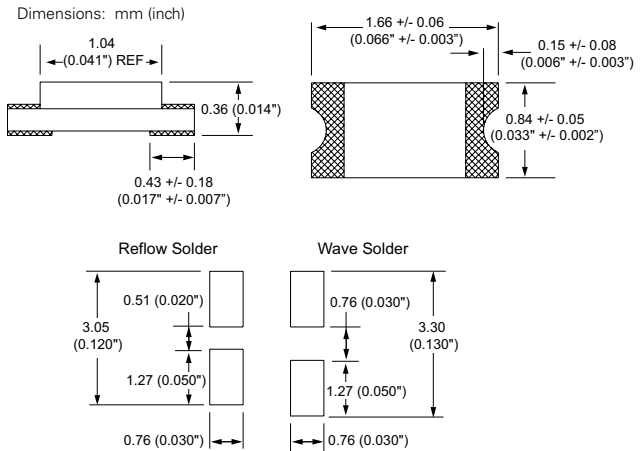

**SOT23 Device**

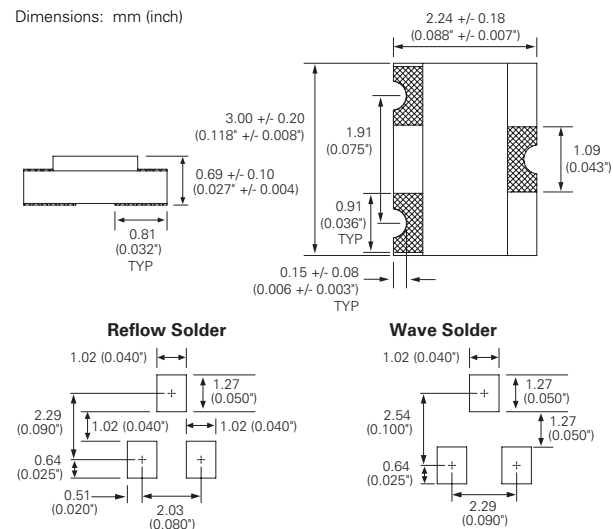

### Physical Specifications

<b>Materials</b>	Body: Glass Epoxy Terminations: Copper/Nickel/Tin
<b>Solderability</b>	MIL-STD-202, Method 208
<b>Soldering Parameters</b>	Wave solder - 260°C, 10 seconds maximum Reflow solder - 260°C, 30 seconds maximum

### Design Consideration

Because of the fast rise-time of the ESD transient, proper placement of PULSE-GUARD® suppressors are a key design consideration to achieving optimal ESD suppression. The devices should be placed on the circuit board as close to the source of the ESD transient as possible. Install PULSE-GUARD® suppressors (connected from signal/data line to ground) directly behind the connector so that they are the first board-level circuit component encountered by the ESD transient.

### Environmental Specifications

<b>Operating Temperature</b>	-65°C to +125°C
<b>Moisture Resistance</b>	0402 series: 40°C, 95% RH, 1000 hours 0603, ST23: 85°C, 85% RH, 1000 hours
<b>Thermal Shock</b>	MIL-STD-202, Method 107, -65°C to 125°C, 30 min. cycle, 10 cycles
<b>Vibration</b>	MIL-STD-202, Method 201, (10 to 55 to 10 Hz, 1 min. cycle, 2 hrs each in X-Y-Z)
<b>Chemical Resistance</b>	MIL-STD-202, Method 215
<b>Solder Leach Resistance and Terminal Adhesion</b>	IPC/EIA J-STD-002

### Soldering Parameters

<b>Reflow Condition</b>	Pb – Free assembly	
<b>Pre Heat</b>	- Temperature Min ( $T_{s(min)}$ )	150°C
	- Temperature Max ( $T_{s(max)}$ )	200°C
	- Time (min to max) ( $t_s$ )	60 – 180 seconds
<b>Average ramp up rate (Liquidus Temp (<math>T_L</math>) to peak)</b>	3°C/second max	
<b><math>T_{s(max)}</math> to <math>T_L</math> - Ramp-up Rate</b>	3°C/second max	
<b>Reflow</b>	- Temperature ( $T_L$ ) (Liquidus)	217°C
	- Temperature ( $t_L$ )	60 – 150 seconds
<b>Peak Temperature (<math>T_p</math>)</b>	260°C	
<b>Time within 5°C of actual peak Temperature (<math>t_p</math>)</b>	10 – 30 seconds	
<b>Ramp-down Rate</b>	6°C/second max	
<b>Time 25°C to peak Temperature (<math>T_p</math>)</b>	8 minutes max	

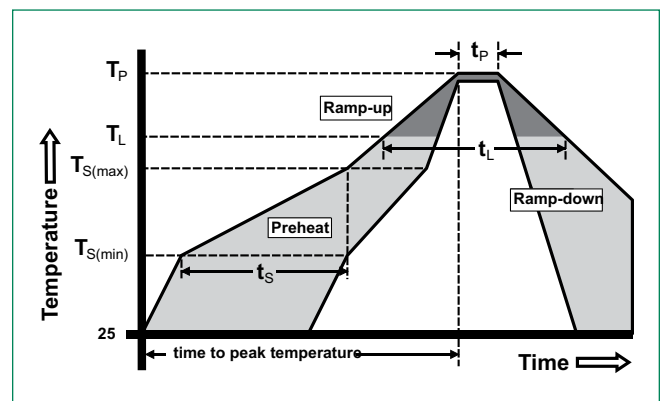

Based on IPC/JEDEC J-STD-020

**Packaging**

Part Number	Quantity & Packaging Code	Quantity	Packaging Option	Packaging Specification
PGB1010402	KR	10000	Tape & Reel (7" reel)	EIA RS-481-1 (IEC 286, part 3)
PGB1010603	MR	1000	Tape & Reel (7" reel)	EIA RS-481-1 (IEC 286, part 3)
PGB102ST23	WR	3000	Tape & Reel (7" reel)	EIA RS-481-1 (IEC 286, part 3)
PGB1010603	NR	5000	Tape & Reel (7" reel)	EIA RS-481-1 (IEC 286, part 3)

**Tape and Reel Specifications**

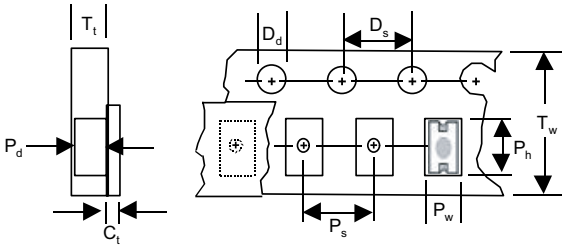

Description	0402 Series (mm)	0603 Series (mm)	SOT23 Series (mm)
C <sub>t</sub> - Cover tape thickness	0.05	0.05	0.06
D <sub>d</sub> - Drive hole diameter	1.50	1.50	1.50
D <sub>s</sub> - Drive hole spacing	4.00	4.00	4.00
P <sub>d</sub> - Pocket depth	0.41	0.58	1.02
P <sub>h</sub> - Pocket height	1.12	1.85	3.23
P <sub>s</sub> - Pocket spacing	2.00	4.00	4.00
P <sub>w</sub> - Pocket width	0.62	1.02	2.46
T <sub>t</sub> - Carrier tape thickness	0.61	0.65	1.77
T <sub>w</sub> - Carrier tape width	8.00	8.00	8.00

**Typical Test Setup**

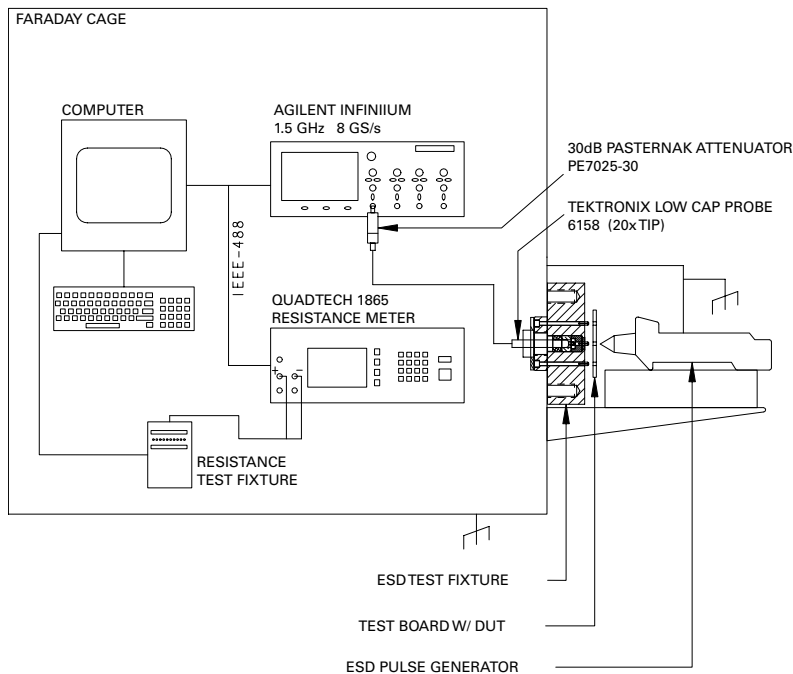

# Mouser Electronics

Authorized Distributor

Click to View Pricing, Inventory, Delivery & Lifecycle Information:

[Littelfuse:](#)

[PGB0010603NR](#) [PGB0010603MR](#) [PGB1010603NRHF](#) [PGB1010402KR](#) [PGB102ST23WR](#) [PGB1010603NR](#)  
[PGB102ST23WRHF](#) [PGB1010603MR](#) [PGB1010603MRHF](#)