

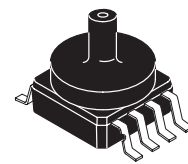
# Media Resistant, Integrated Silicon Pressure Sensor for Manifold Absolute Pressure, Altimeter or Barometer Applications

## On-Chip Signal Conditioned, Temperature Compensated, and Calibrated

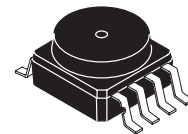
### MPXAZ4115A SERIES

INTEGRATED PRESSURE SENSOR  
 15 to 115 kPa (2.2 to 16.7 psi)  
 0.2 to 4.8 V Output

#### SMALL OUTLINE PACKAGE



MPXAZ4115AC6U  
 CASE 482A



MPXAZ4115A6U  
 CASE 482

Motorola's MPXAZ4115A series sensor integrates on-chip, bipolar op amp circuitry and thin film resistor networks to provide a high output signal and temperature compensation. The small form factor and high reliability of on-chip integration make the Motorola pressure sensor a logical and economical choice for the system designer.

The MPXAZ4115A series piezoresistive transducer is a state-of-the-art, monolithic, signal conditioned, silicon pressure sensor. This sensor combines advanced micromachining techniques, thin film metallization, and bipolar semiconductor processing to provide an accurate, high level analog output signal that is proportional to applied pressure.

Figure 1 shows a block diagram of the internal circuitry integrated on a pressure sensor chip.

#### Features

- Resistant to high humidity and common automotive media
- 1.5% Maximum Error over 0° to 85°C
- Ideally suited for Microprocessor or Microcontroller-Based Systems
- Temperature Compensated from -40° to +125°C
- Durable Thermoplastic (PPS) Surface Mount Package

#### Application Examples

- Aviation Altimeters
- Industrial Controls
- Engine Control
- Weather Stations and Weather Reporting Devices

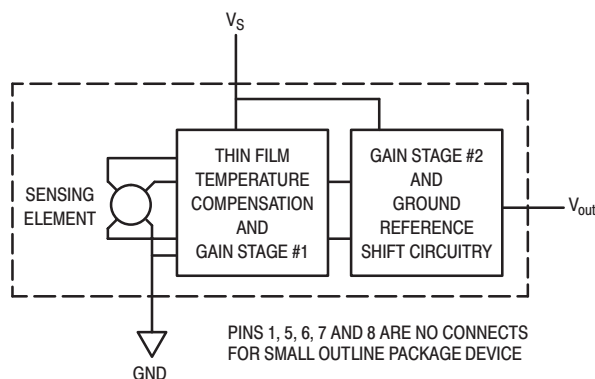


Figure 1. Fully Integrated Pressure Sensor Schematic

PIN NUMBER			
1	N/C	5	N/C
2	V <sub>S</sub>	6	N/C
3	Gnd	7	N/C
4	V <sub>out</sub>	8	N/C

NOTE: Pins 1, 5, 6, 7, and 8 are not device connections. Do not connect to external circuitry or ground. Pin 1 is noted by the notch in the lead.

**MAXIMUM RATINGS**<sup>(NOTE)</sup>

Parametrics	Symbol	Value	Units
Maximum Pressure (P1 > P2)	$P_{max}$	400	kPa
Storage Temperature	$T_{stg}$	-40° to +125°	°C
Operating Temperature	$T_A$	-40° to +125°	°C

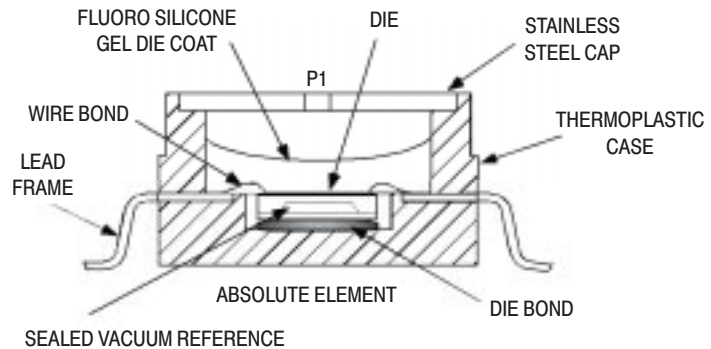
NOTE: Exposure beyond the specified limits may cause permanent damage or degradation to the device.

**OPERATING CHARACTERISTICS** ( $V_S = 5.1$  Vdc,  $T_A = 25^\circ\text{C}$  unless otherwise noted, P1 > P2. Decoupling circuit shown in Figure 3 required to meet Electrical Specifications.)

Characteristic	Symbol	Min	Typ	Max	Unit
Pressure Range	$P_{OP}$	15	—	115	kPa
Supply Voltage <sup>(1)</sup>	$V_S$	4.85	5.1	5.35	Vdc
Supply Current	$I_o$	—	7.0	10	mAdc
Minimum Pressure Offset <sup>(2)</sup> @ $V_S = 5.1$ Volts	$V_{off}$	0.135	0.204	0.273	Vdc
Full Scale Output <sup>(3)</sup> @ $V_S = 5.1$ Volts	$V_{FSO}$	4.725	4.794	4.863	Vdc
Full Scale Span <sup>(4)</sup> @ $V_S = 5.1$ Volts	$V_{FSS}$	4.521	4.590	4.659	Vdc
Accuracy <sup>(5)</sup>	—	—	—	±1.5	% $V_{FSS}$
Sensitivity	V/P	—	45.9	—	mV/kPa
Response Time <sup>(6)</sup>	$t_R$	—	1.0	—	ms
Output Source Current at Full Scale Output	$I_{o+}$	—	0.1	—	mAdc
Warm-Up Time <sup>(7)</sup>	—	—	20	—	ms
Offset Stability <sup>(8)</sup>	—	—	±0.5	—	% $V_{FSS}$

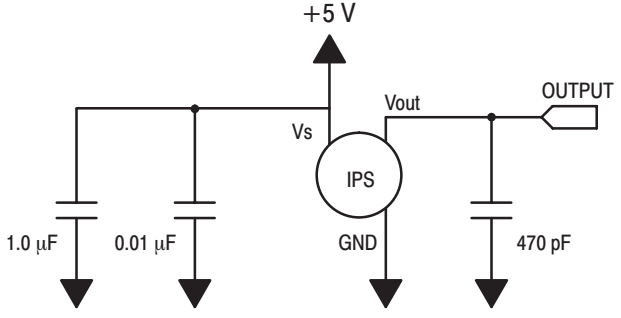
**NOTES:**

- Device is ratiometric within this specified excitation range.
- Offset ( $V_{off}$ ) is defined as the output voltage at the minimum rated pressure.
- Full Scale Output ( $V_{FSO}$ ) is defined as the output voltage at the maximum or full rated pressure.
- Full Scale Span ( $V_{FSS}$ ) is defined as the algebraic difference between the output voltage at full rated pressure and the output voltage at the minimum rated pressure.
- Accuracy is the deviation in actual output from nominal output over the entire pressure range and temperature range as a percent of span at 25°C due to all sources of error including the following:
  - Linearity: Output deviation from a straight line relationship with pressure over the specified pressure range.
  - Temperature Hysteresis: Output deviation at any temperature within the operating temperature range, after the temperature is cycled to and from the minimum or maximum operating temperature points, with zero differential pressure applied.
  - Pressure Hysteresis: Output deviation at any pressure within the specified range, when this pressure is cycled to and from minimum or maximum rated pressure at 25°C.
  - TcSpan: Output deviation over the temperature range of 0° to 85°C, relative to 25°C.
  - TcOffset: Output deviation with minimum pressure applied, over the temperature range of 0° to 85°C, relative to 25°C.
- Response Time is defined as the time for the incremental change in the output to go from 10% to 90% of its final value when subjected to a specified step change in pressure.
- Warm-up Time is defined as the time required for the product to meet the specified output voltage after the pressure has been stabilized.
- Offset Stability is the product's output deviation when subjected to 1000 cycles of Pulsed Pressure, Temperature Cycling with Bias Test.



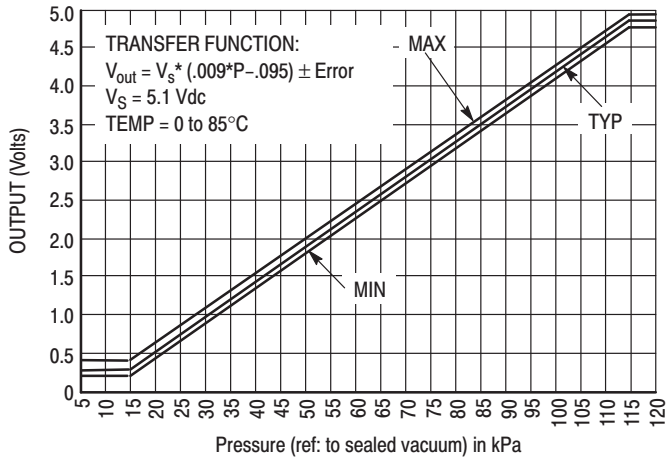
**Figure 2. Cross Sectional Diagram SOP (not to scale)**

Figure 2 illustrates the absolute sensing chip in the basic chip carrier (Case 482).



**Figure 3. Recommended power supply decoupling and output filtering.**  
 For additional output filtering, please refer to Application Note AN1646.

Figure 3 shows the recommended decoupling circuit for interfacing the output of the integrated sensor to the A/D input of a microprocessor or microcontroller. Proper decoupling of the power supply is recommended.



**Figure 4. Output versus Absolute Pressure**

Figure 4 shows the sensor output signal relative to pressure input. Typical minimum and maximum output curves are shown for operation over a temperature range of 0 to 85°C using the decoupling circuit shown in Figure 3. The output will saturate outside of the specified pressure range.

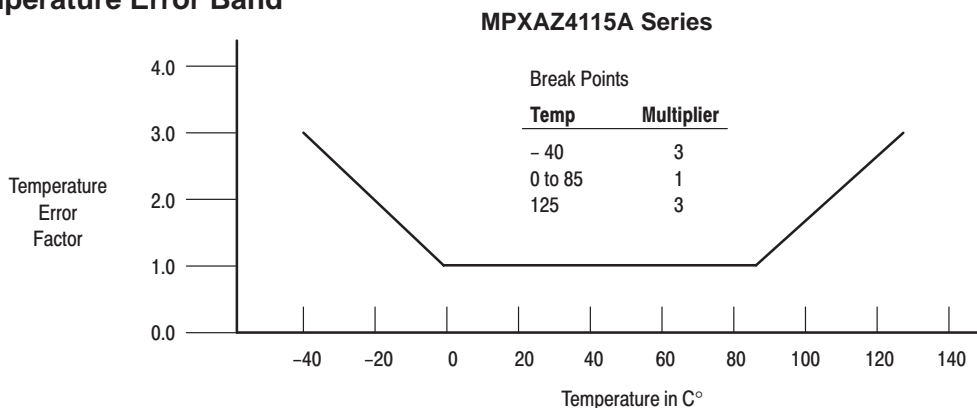
A gel die coat isolates the die surface and wire bonds from the environment, while allowing the pressure signal

to be transmitted to the sensor diaphragm. The gel die coat and durable polymer package provide a media resistant barrier that allows the sensor to operate reliably in high humidity conditions as well as environments containing common automotive media. Contact the factory for more information regarding media compatibility in your specific application.

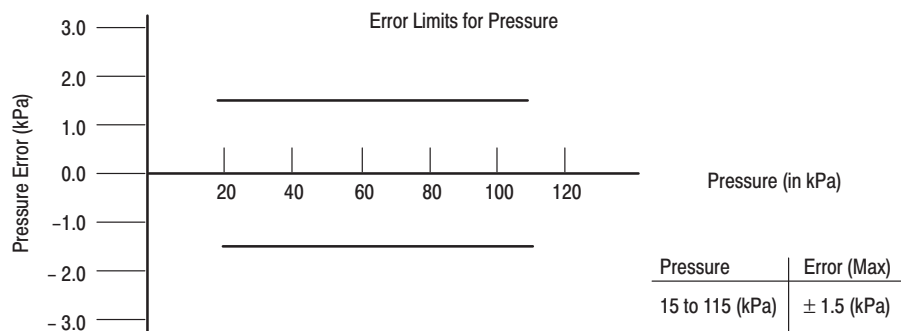
Freescale Semiconductor, Inc. ARCHIVED BY FREESCALE SEMICONDUCTOR, INC. 2005

**Transfer Function (MPXAZ4115A)**

**Nominal Transfer Value:**  $V_{out} = V_S \times (0.009 \times P - 0.095)$   
 $\pm (\text{Pressure Error} \times \text{Temp. Factor} \times 0.009 \times V_S)$   
 $V_S = 5.1 \pm 0.25 \text{ Vdc}$

**Temperature Error Band**


NOTE: The Temperature Multiplier is a linear response from 0°C to -40°C and from 85°C to 125°C

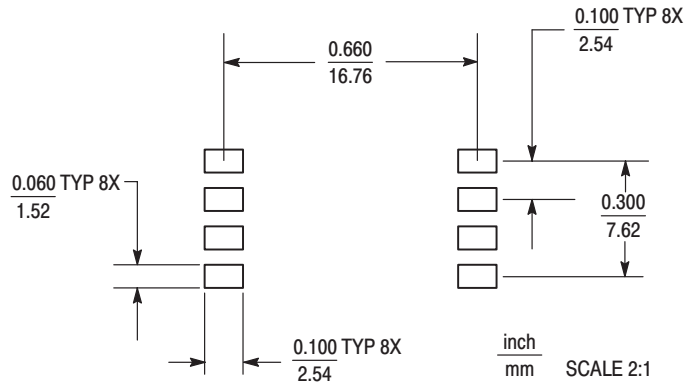
**Pressure Error Band**

**ORDERING INFORMATION — SMALL OUTLINE PACKAGE**

Device Type	Options	Case No.	MPX Series Order No.	Packing Options	Marking
Basic Element	Absolute, Element Only	482	MPXAZ4115A6U	Rails	MPXAZ4115A
	Absolute, Element Only	482	MPXAZ4115A6T1	Tape and Reel	MPXAZ4115A
Ported Element	Absolute, Axial Port	482A	MPXAZ4115AC6U	Rails	MPXAZ4115A
	Absolute, Axial Port	482A	MPXAZ4115AC6T1	Tape and Reel	MPXAZ4115A

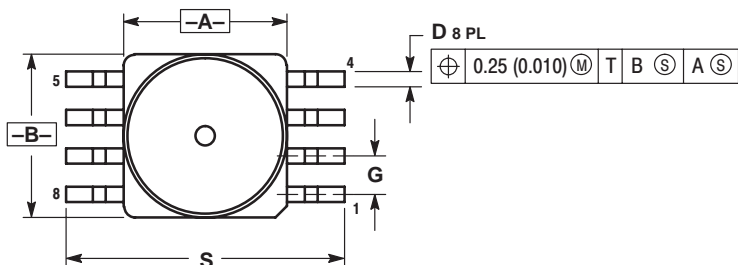
**MINIMUM RECOMMENDED FOOTPRINT FOR SURFACE MOUNTED APPLICATIONS**

Surface mount board layout is a critical portion of the total design. The footprint for the surface mount packages must be the correct size to ensure proper solder connection interface between the board and the package. With the correct

footprint, the packages will self-align when subjected to a solder reflow process. It is always recommended to design boards with a solder mask layer to avoid bridging and shorting between solder pads.

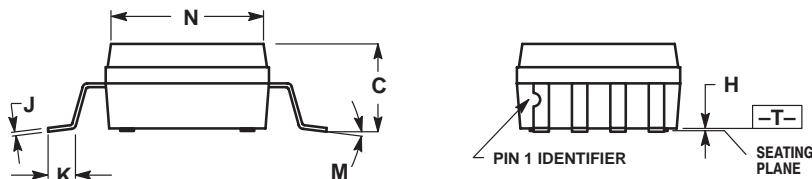


**Figure 5. SOP Footprint (Case 482)**

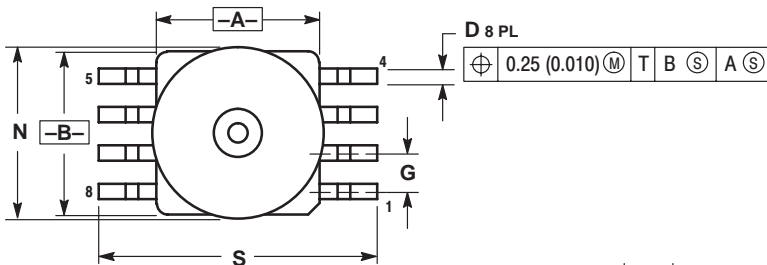


- NOTES:
1. DIMENSIONING AND TOLERANCING PER ANSI Y14.5M, 1982.
  2. CONTROLLING DIMENSION: INCH.
  3. DIMENSION A AND B DO NOT INCLUDE MOLD PROTRUSION.
  4. MAXIMUM MOLD PROTRUSION 0.15 (0.006).
  5. ALL VERTICAL SURFACES 5° TYPICAL DRAFT.

DIM	INCHES		MILLIMETERS	
	MIN	MAX	MIN	MAX
A	0.415	0.425	10.54	10.79
B	0.415	0.425	10.54	10.79
C	0.212	0.230	5.38	5.84
D	0.038	0.042	0.96	1.07
G	0.100 BSC		2.54 BSC	
H	0.002	0.010	0.05	0.25
J	0.009	0.011	0.23	0.28
K	0.061	0.071	1.55	1.80
M	0°	7°	0°	7°
N	0.405	0.415	10.29	10.54
S	0.709	0.725	18.01	18.41

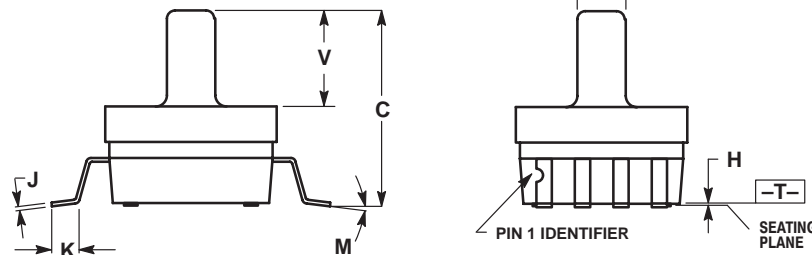


**CASE 482-01  
ISSUE O**




- NOTES:
1. DIMENSIONING AND TOLERANCING PER ANSI Y14.5M, 1982.
  2. CONTROLLING DIMENSION: INCH.
  3. DIMENSION A AND B DO NOT INCLUDE MOLD PROTRUSION.
  4. MAXIMUM MOLD PROTRUSION 0.15 (0.006).
  5. ALL VERTICAL SURFACES 5° TYPICAL DRAFT.

DIM	INCHES		MILLIMETERS	
	MIN	MAX	MIN	MAX
A	0.415	0.425	10.54	10.79
B	0.415	0.425	10.54	10.79
C	0.500	0.520	12.70	13.21
D	0.038	0.042	0.96	1.07
G	0.100 BSC		2.54 BSC	
H	0.002	0.010	0.05	0.25
J	0.009	0.011	0.23	0.28
K	0.061	0.071	1.55	1.80
M	0°	7°	0°	7°
N	0.444	0.448	11.28	11.38
S	0.709	0.725	18.01	18.41
V	0.245	0.255	6.22	6.48
W	0.115	0.125	2.92	3.17



**CASE 482A-01  
ISSUE A**



Motorola reserves the right to make changes without further notice to any products herein. Motorola makes no warranty, representation or guarantee regarding the suitability of its products for any particular purpose, nor does Motorola assume any liability arising out of the application or use of any product or circuit, and specifically disclaims any and all liability, including without limitation consequential or incidental damages. "Typical" parameters which may be provided in Motorola data sheets and/or specifications can and do vary in different applications and actual performance may vary over time. All operating parameters, including "Typicals" must be validated for each customer application by customer's technical experts. Motorola does not convey any license under its patent rights nor the rights of others. Motorola products are not designed, intended, or authorized for use as components in systems intended for surgical implant into the body, or other applications intended to support or sustain life, or for any other application in which the failure of the Motorola product could create a situation where personal injury or death may occur. Should Buyer purchase or use Motorola products for any such unintended or unauthorized application, Buyer shall indemnify and hold Motorola and its officers, employees, subsidiaries, affiliates, and distributors harmless against all claims, costs, damages, and expenses, and reasonable attorney fees arising out of, directly or indirectly, any claim of personal injury or death associated with such unintended or unauthorized use, even if such claim alleges that Motorola was negligent regarding the design or manufacture of the part. Motorola and  are registered trademarks of Motorola, Inc. Motorola, Inc. is an Equal Opportunity/Affirmative Action Employer.

**How to reach us:**

**USA/EUROPE/Locations Not Listed:** Motorola Literature Distribution;  
P.O. Box 5405, Denver, Colorado 80217. 1-303-675-2140 or 1-800-441-2447

**JAPAN:** Motorola Japan Ltd.; SPS, Technical Information Center, 3-20-1,  
Minami-Azabu, Minato-ku, Tokyo 106-8573 Japan. 81-3-3440-3569

**Technical Information Center: 1-800-521-6274**

**ASIA/PACIFIC:** Motorola Semiconductors H.K. Ltd.; Silicon Harbour Centre,  
2, Dai King Street, Tai Po Industrial Estate, Tai Po, N.T., Hong Kong.  
852-26668334

**HOME PAGE:** <http://www.motorola.com/semiconductors/>



**MOTOROLA**

**For More Information On This Product,  
Go to: [www.freescale.com](http://www.freescale.com)**

**MPXAZ4115A/D**

# Mouser Electronics

Authorized Distributor

Click to View Pricing, Inventory, Delivery & Lifecycle Information:

[NXP:](#)

[MPXAZ4115AC6U](#) [MPXAZ4115A6U](#) [MPXA4115AP](#) [MPX4115AP](#) [MPX4115AS](#) [MPXA4115A6U](#) [MPX4115A](#)  
[MPXA4115AC6U](#) [MPXV4115V6T1](#) [MPXAZ4115A6T1](#) [MPXV4115V6U](#) [MPXA4115A6T1](#)