

## **5082-761x/-762x/-765x/-766x Series, HDSP-360x/-460x/-E15x Series 7.6 mm (0.3 inch)/10.9 mm (0.43 inch) Seven-Segment Displays**



### **Description**

The Broadcom® 7.6 mm (0.3 inch) and 10.9 mm (0.43 inch) LED seven-segment displays are designed for viewing distances up to 3 meters (10 feet) and 5 meters (16 feet). These devices use industry-standard size packages and pinouts. All devices are available as either common anode or common cathode.

### **Features**

- Industry-standard size
- Industry-standard pinout
  - 7.62 mm (0.300 in.) DIP leads on 2.54 mm (0.100 in.) centers
- Choice of colors
  - AllnGaP deep red, high efficiency red (HER), AllnGaP yellow, and green
- Excellent appearance
  - Evenly lighted segments
  - $\pm 50^\circ$  viewing angle
  - Optimum contrast given by gray top surface for AllnGaP deep red and green devices
  - Red top surface for HER devices
  - Yellow top surface for yellow devices
- Design flexibility
  - Common anode or common cathode
  - Single digits
- Categorized for luminous intensity
  - Yellow and green categorized for color
  - Use of like categories yields a uniform display

# Package Drawing

## Package Dimensions

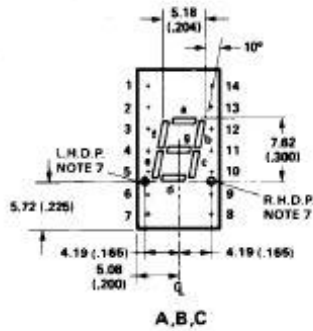

PIN	FUNCTION		
	A	B	C
1	CATHODE-a	CATHODE-a	NO PIN
2	CATHODE-f	CATHODE-f	CATHODE <sup>(1)</sup>
3	ANODE <sup>(2)</sup>	ANODE <sup>(2)</sup>	ANODE-f
4	NO PIN	NO PIN	ANODE-g
5	NO PIN	NO PIN	ANODE-e
6	CATHODE-dp	NO CONN. <sup>(3)</sup>	ANODE-d
7	CATHODE-e	CATHODE-e	NO PIN
8	CATHODE-d	CATHODE-d	NO PIN
9	NO CONN. <sup>(3)</sup>	CATHODE-dp	CATHODE <sup>(1)</sup>
10	CATHODE-c	CATHODE-c	ANODE-dp
11	CATHODE-g	CATHODE-g	ANODE-c
12	NO PIN	NO PIN	ANODE-b
13	CATHODE-b	CATHODE-b	ANODE-a
14	ANODE <sup>(2)</sup>	ANODE <sup>(2)</sup>	NO PIN

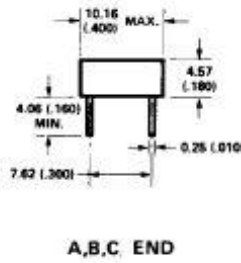
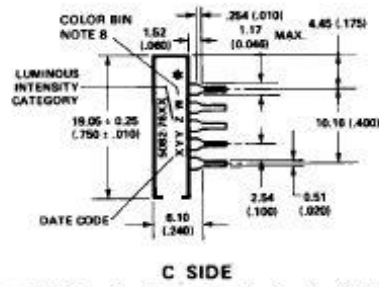
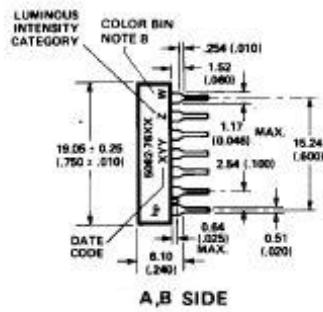

- NOTES:
1. DIMENSIONS IN MILLIMETRES AND (INCHE).
  2. ALL UNTOLERANCED DIMENSIONS ARE FOR REFERENCE ONLY.
  3. REDUNDANT ANODES.
  4. UNUSED DP POSITION.
  5. SEE INTERNAL CIRCUIT DIAGRAM.
  6. REDUNDANT CATHODE.
  7. SEE PART NUMBER TABLE FOR L.H.D.P. AND R.H.D.P. DESIGNATION.
  8. FOR YELLOW AND GREEN DEVICES ONLY.

\*The Side View of package indicates Country of Origin.

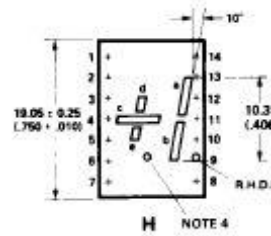
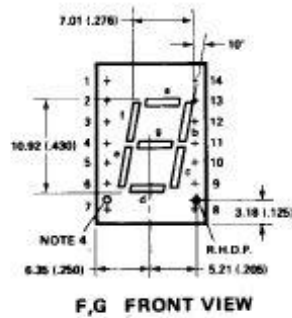
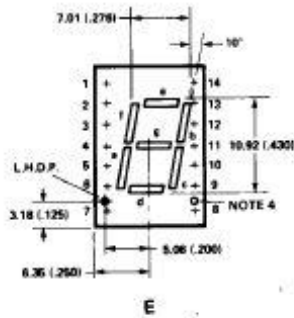

PIN	FUNCTION			
	E	F	G	H
1	CATHODE-e	CATHODE-e	ANODE-a	CATHODE-d
2	CATHODE-f	CATHODE-f	ANODE-f	ANODE-d
3	ANODE <sup>(2)</sup>	ANODE <sup>(2)</sup>	CATHODE <sup>(1)</sup>	NO PIN
4	NO PIN	NO PIN	NO PIN	CATHODE-c
5	NO PIN	NO PIN	NO PIN	CATHODE-e
6	CATHODE-dp	NO CONN. <sup>(3)</sup>	NO CONN. <sup>(3)</sup>	ANODE-e
7	CATHODE-e	CATHODE-e	ANODE-e	ANODE-c
8	CATHODE-d	CATHODE-d	ANODE-d	ANODE-dp
9	NO CONN. <sup>(3)</sup>	CATHODE-dp	ANODE-dp	CATHODE-dp
10	CATHODE-c	CATHODE-c	ANODE-c	CATHODE-b
11	CATHODE-g	CATHODE-g	ANODE-g	CATHODE-a
12	NO PIN	NO PIN	NO PIN	NO PIN
13	CATHODE-b	CATHODE-b	ANODE-b	ANODE-a
14	ANODE <sup>(2)</sup>	ANODE <sup>(2)</sup>	CATHODE <sup>(1)</sup>	ANODE-b

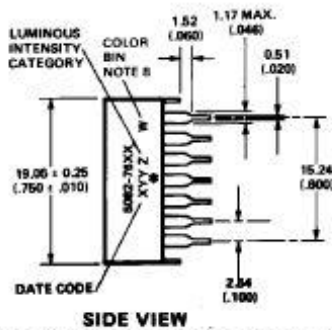
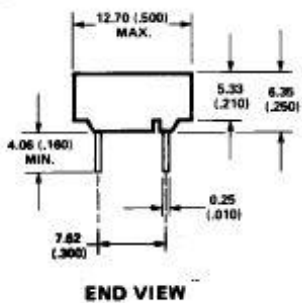

\*The Side View of package indicates Country of Origin.

## Internal Circuit Diagram

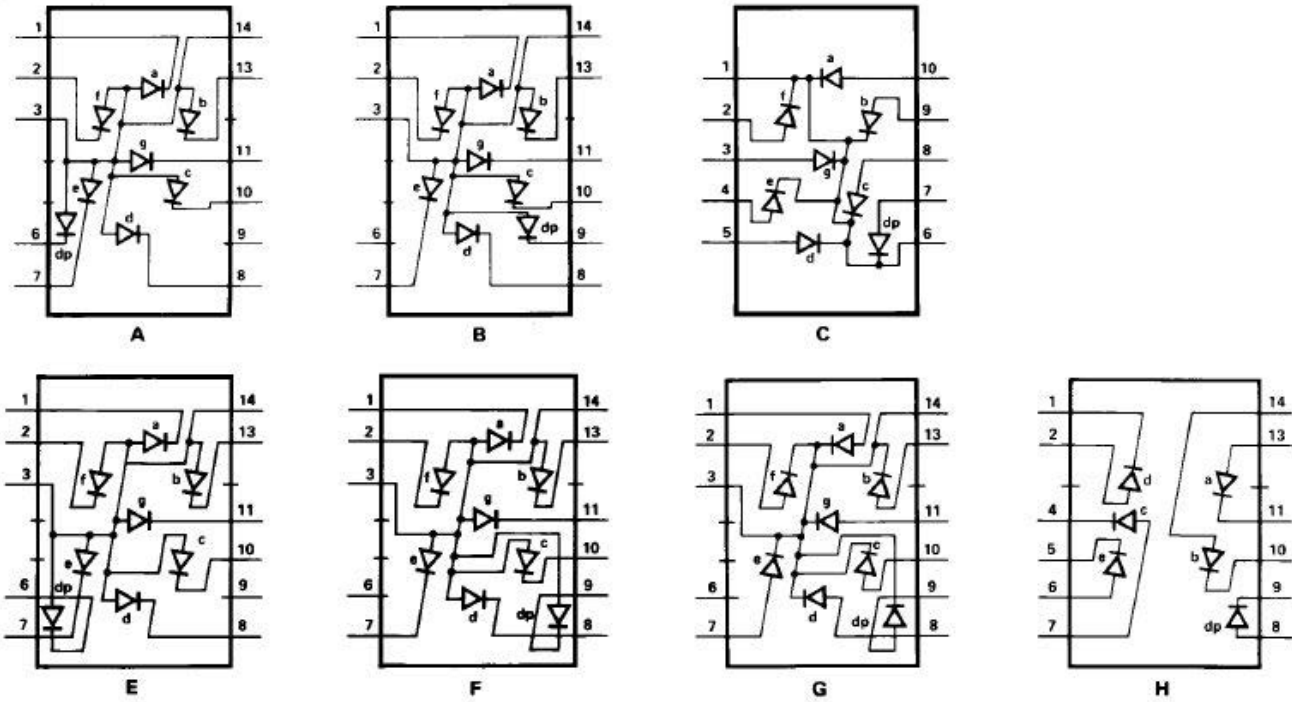

## Device Selection Guide

AllInGaP Deep Red HDSP-	HER <sup>a</sup>	AllInGaP Yellow 5082-	Green HDSP-	Description	Package Drawing
	7610	7620	3600	7.6-mm Common Anode Left-Hand Decimal	A
	7611	7621	3601	7.6-mm Common Anode Right-Hand Decimal	B
	7613	7623	3603	7.6-mm Common Cathode Right-Hand Decimal	C
	7650	—	4600	10.9-mm Common Anode Left-Hand Decimal	E
E151	7651	7661	4601	10.9-mm Common Anode Right-Hand Decimal	F
E153	7653	7663	4603	10.9-mm Common Cathode Right-Hand Decimal	G

a. These displays are recommended for high ambient light operation. Refer to the HDSP-335X HER data sheet for low current operation.

## Absolute Maximum Ratings

Description	Deep Red HDSP-E150 Series	HER 5082-7610/7650 Series	Yellow 5082-7620/7660 Series	Green HDSP-3600/4600 Series	Units
Power Dissipation per Segment or DP	100	75	50	75	mW
Peak Forward Current per Segment or DP <sup>a</sup>	90	90	60	90	mA
DC Forward Current per Segment or DP <sup>b</sup>	40	30	20	30	mA
Operating Temperature Range	-20 to +100	-40 to +100			°C
Storage Temperature Range	-55 to +100				°C
Reverse Voltage per Segment or DP <sup>c</sup>	3.0V				V
Wave Soldering Temperature for 3 Seconds (1.59 mm [0.063 in.] below Body)	250				°C

a. Duty factor = 10%, frequency = 1 kHz, TA = 25°C.

b. Derate linearly as shown in [Figure 4](#) (Deep Red) and [Figure 8](#) (HER, Green), and [Figure 12](#) (Yellow).

c. Reverse voltage is for LED testing purposes and is not recommended to be used as an application condition.

## Electrical/Optical Characteristics at $T_A = 25^\circ\text{C}$

Parameter	Symbol	Min.	Typ.	Max.	Unit	Test Condition
<b>Deep Red, Device Series HDSP-E15x</b>						
Luminous Intensity/Segment (Digital Average) <sup>a, b</sup>	$I_V$	8.5	28.0	—	mcd	$I_F = 20\text{ mA}$
Forward Voltage/Segment or DP <sup>c</sup>	$V_F$	—	2.1	2.5	V	$I_F = 20\text{ mA}$
Peak Wavelength	$\lambda_p$	—	656	—	nm	
Dominant Wavelength <sup>d</sup>	$\lambda_d$	—	639	—	nm	
Reverse Voltage/Segment or DP <sup>e</sup>	$V_R$	3.0	—	—	V	$I_R = 100\ \mu\text{A}$
<b>High Efficiency Red, Device Series 5082-761x and 5082-765x</b>						
Luminous Intensity/Segment (Digital Average) <sup>a, b</sup>	$I_V$				mcd	$I_F = 5\text{ mA}$
5082-761x		0.34	0.80	—		
5082-765x		0.34	1.115	—		
Forward Voltage/Segment or DP <sup>c</sup>	$V_F$	—	2.1	2.5	V	$I_F = 20\text{ mA}$
Peak Wavelength	$\lambda_p$	—	635	—	nm	
Dominant Wavelength <sup>d</sup>	$\lambda_d$	—	626	—	nm	
Reverse Voltage/Segment or DP <sup>e</sup>	$V_R$	3.0	30	—	V	$I_R = 100\ \mu\text{A}$
<b>Yellow, Device Series 5082-762x and 5082-766x</b>						
Luminous Intensity/Segment (Digital Average) <sup>a, b</sup>	$I_V$				mcd	$I_F = 5\text{ mA}$
5082-762x		0.205	2.68	—		
5082-766x		0.29	2.58	—		
Forward Voltage/Segment or DP <sup>c</sup>	$V_F$	—	2.0	2.5	V	$I_F = 20\text{ mA}$
Peak Wavelength	$\lambda_p$	—	591	—	nm	
Dominant Wavelength <sup>d</sup>	$\lambda_d$	581.5	588	592.5	nm	
Reverse Voltage/Segment or DP <sup>e</sup>	$V_R$	3.0	—	—	V	$I_R = 100\ \mu\text{A}$
<b>High-Performance Green, Device Series HDSP-360x and HDSP-460x</b>						
Luminous Intensity/Segment (Digital Average) <sup>a, b</sup>	$I_V$				mcd	$I_F = 10\text{ mA}$
HDSP-360x		0.86	2.70	—		
HDSP-460x		1.03	4.00	—		
Forward Voltage/Segment or DP <sup>c</sup>	$V_F$	—	2.1	2.5	V	$I_F = 10\text{ mA}$
Peak Wavelength	$\lambda_p$	—	566	—	nm	
Dominant Wavelength <sup>d</sup>	$\lambda_d$	—	571	577	nm	
Reverse Voltage/Segment or DP <sup>e</sup>	$V_R$	3.0	50	—	V	$I_R = 100\ \mu\text{A}$

- The luminous intensity,  $I_V$ , is measured at the mechanical axis of the package.
- The optical axis is closely aligned with the mechanical axis of the package.
- Forward voltage tolerance is  $\pm 0.1\text{V}$ .
- The dominant wavelength,  $\lambda_d$ , is derived from the CIE Chromaticity Diagram and represents the color of the device.
- Typical specification for reference only. Do not exceed absolute maximum ratings, and long-term reverse bias is not recommended.

## Part Numbering System

5082 - X XX X - X X X X  
HDSP - X XX X - X X X X

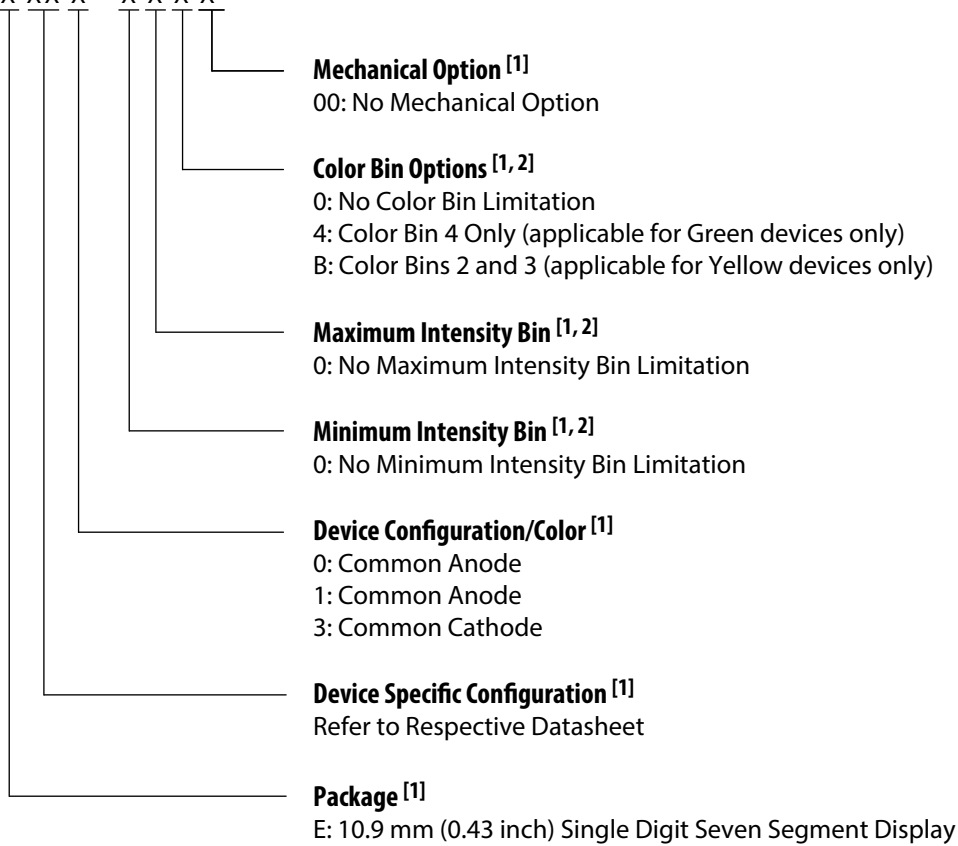

1. For codes not listed in the figure above, please refer to the respective data sheet or contact your nearest Broadcom representative for details.
2. Bin options refer to shippable bins for a part number. Color and Intensity Bins are typically restricted to one bin per tube (exceptions may apply). Refer to the respective data sheet for specific bin limit information.

## Intensity Bin Limits (mcd)

Table 1: Deep Red: HDSP-E15x

IV Bin Category	Min.	Max.
L	8.67	15.90
M	13.00	23.80
N	19.50	35.80
O	29.30	53.60
P	43.90	80.50

Table 2: HER: 5082-761x

IV Bin Category	Min.	Max.
B	0.369	0.630
C	0.516	0.946
D	0.774	1.418
E	1.160	2.127
F	1.740	3.190
G	2.610	4.785
H	3.915	7.177

Table 3: HER: 5082-765x

IV Bin Category	Min.	Max.
B	0.347	0.593
C	0.485	0.890
D	0.728	1.333
E	1.091	2.000
F	1.636	3.000
G	2.454	4.500
H	3.682	6.751

Table 4: Yellow: 5082-762x

IV Bin Category	Min.	Max.
B	0.229	0.387
C	0.317	0.582
D	0.476	0.872
E	0.714	1.311
F	1.073	1.967
G	1.609	2.950
H	2.413	4.425
I	3.621	6.639
J	5.432	9.958

Table 5: Yellow: 5082-766x

IV Bin Category	Min.	Max.
C	0.297	0.543
D	0.445	0.817
E	0.669	1.225
F	1.003	1.838
G	1.504	2.758
H	2.256	4.137
I	3.385	6.206
J	5.078	9.309

Table 6: Green: HDSP-360x

IV Bin Category	Min.	Max.
H	0.86	1.58
I	1.29	2.37
J	1.94	3.55
K	2.90	5.33
L	4.37	8.01

Table 7: Green: HDSP-460x

IV Bin Category	Min.	Max.
G	1.03	1.88
H	1.54	2.82
I	2.31	4.23
J	3.46	6.34
K	5.18	9.50
L	7.78	14.26

Table 8: Color Categories

Color	Bin	Dominant Wavelength (nm)	
		Min.	Max.
Yellow	1	581.50	585.00
	3	584.00	587.50
	2	586.50	590.00
	4	589.00	592.50
Green	2	573.00	577.00
	3	570.00	574.00
	4	567.00	571.00
	5	564.00	568.00

**NOTE:** All categories are established for classification of products. Products may not be available in all categories. Please contact your Broadcom representatives for further clarification/information.

# Deep Red Graphs

Figure 1: Relative Intensity vs. Wavelength

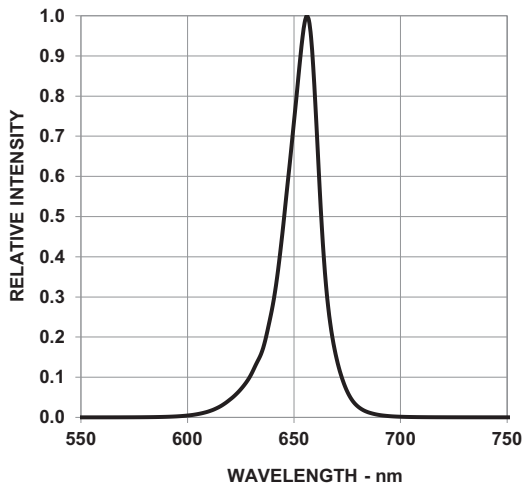

Figure 2: Forward Current vs. Forward Voltage

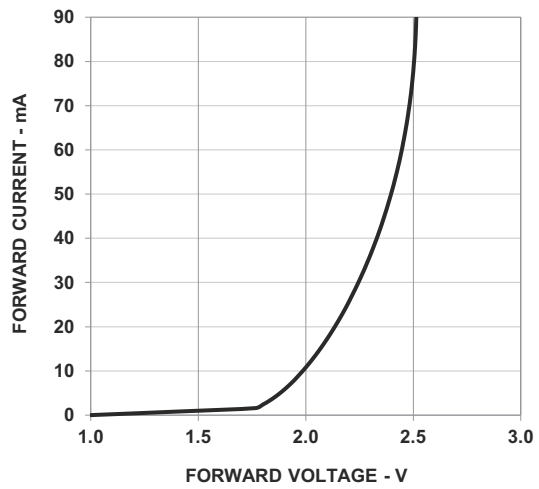

Figure 3: Relative Luminous Intensity vs. Forward Current

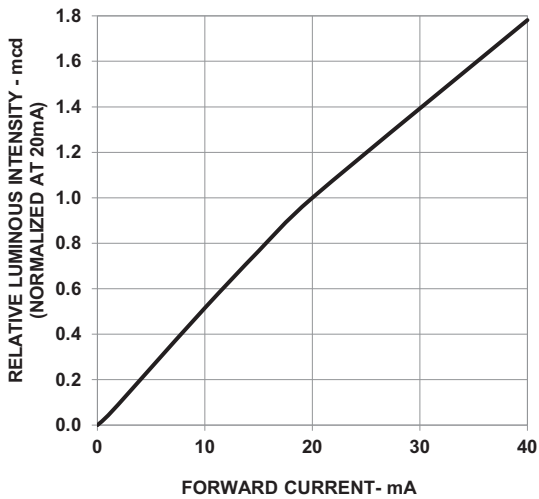
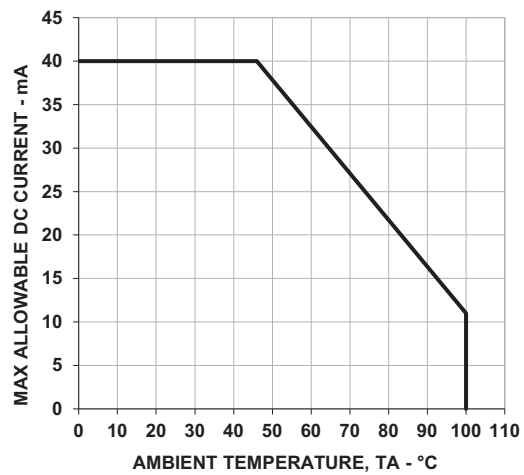

Figure 4: Maximum Forward Current vs. Ambient Temperature





# HER and Green Graphs

Figure 5: Relative Intensity vs. Wavelength

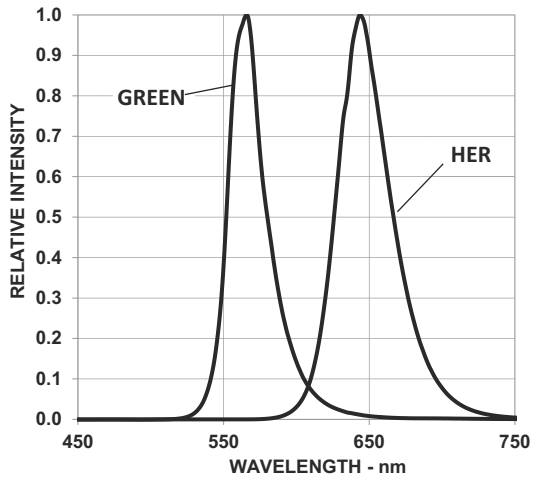

Figure 6: Forward Current vs. Forward Voltage

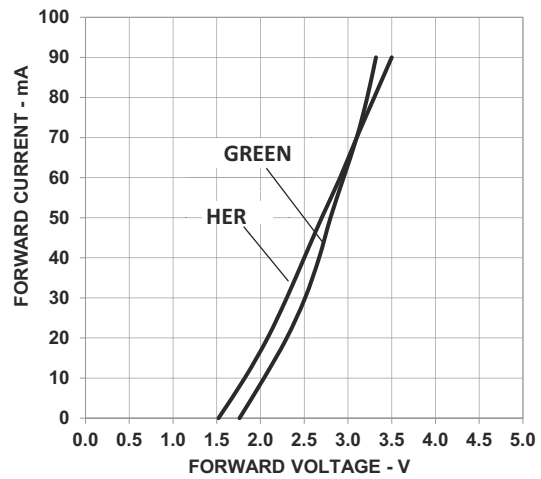

Figure 7: Relative Luminous Intensity vs. Forward Current

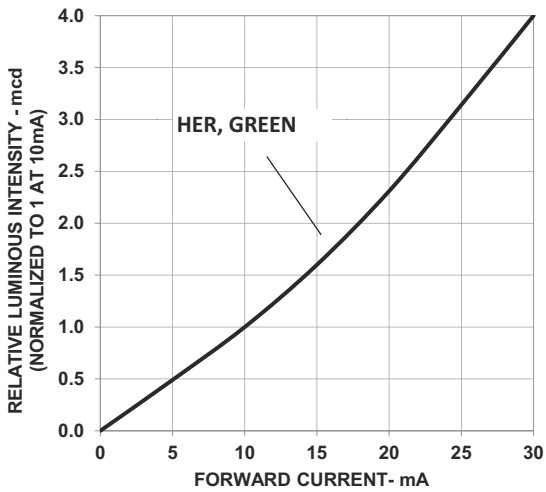
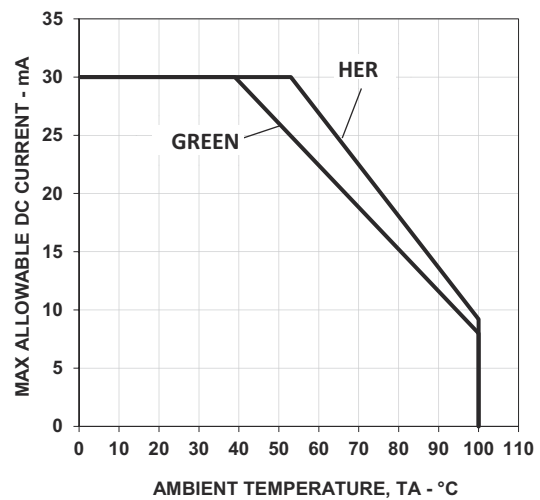

Figure 8: Maximum Forward Current vs. Ambient Temperature



# Yellow Graphs

Figure 9: Relative Intensity vs. Wavelength

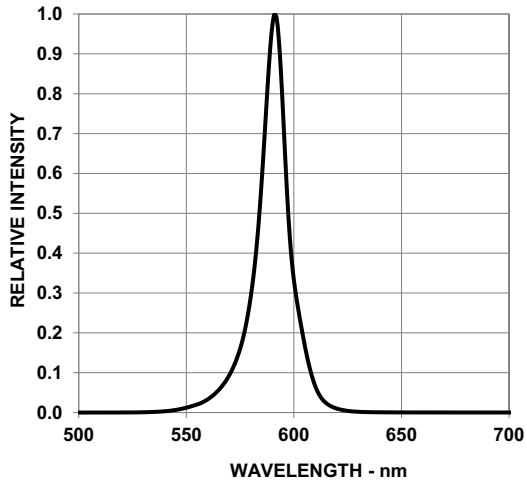

Figure 10: Forward Current vs. Forward Voltage

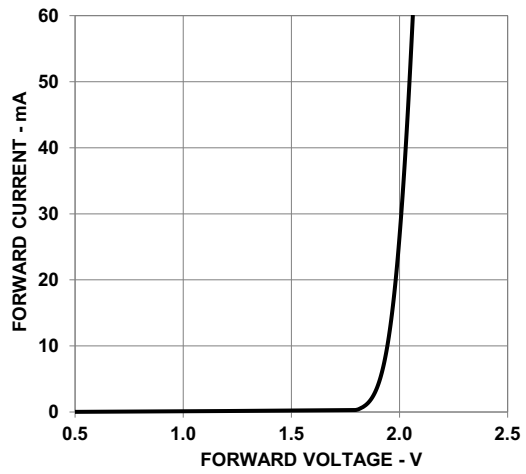

Figure 11: Relative Luminous Intensity vs. Forward Current

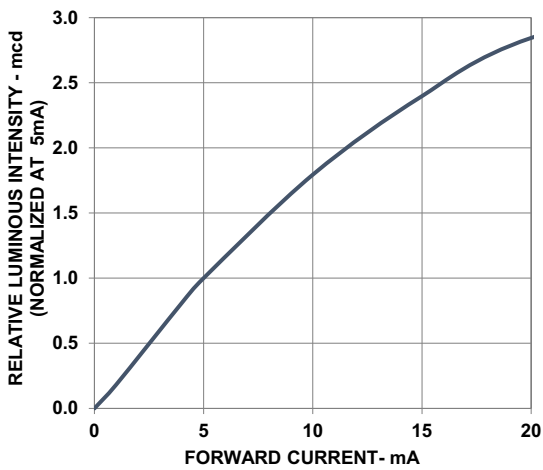
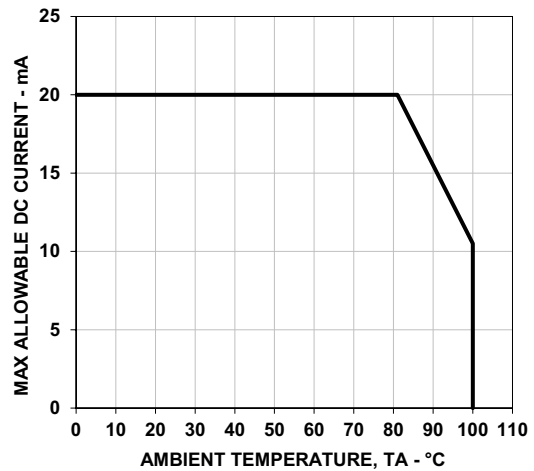

Figure 12: Maximum Forward Current vs. Ambient Temperature



## Precautionary Notes

### Soldering and Handling Precautions

- Set and maintain the wave soldering parameters according to the recommended temperature and dwell time. Perform daily checks on the profile to ensure that it is always conforming to the recommended conditions. Exceeding these conditions will over-stress the LEDs and cause premature failures.
- Use only bottom preheaters to reduce thermal stress experienced by the LEDs.
- Recalibrate the soldering profile before loading a new type of a PCB. PCBs with different sizes and designs (component density) will have different heat capacities and might cause a change in temperature experienced by the PCB if the same wave soldering setting is used.
- Do not perform wave soldering more than once.
- Any alignment fixture used during wave soldering must be loosely fitted and must not apply stress on the LEDs. Use non-metal material because it will absorb less heat during the wave soldering process.
- At elevated temperatures, the LEDs are more susceptible to mechanical stress. Allow the PCB to be sufficiently cooled to room temperature before handling. Do not apply stress to the LED when it is hot.
- Use wave soldering to solder the LED. Use hand soldering only for rework or touch up if unavoidable, but it must be strictly controlled to following conditions:
  - Soldering iron tip temperature = 315°C maximum.
  - Soldering duration = 2 seconds maximum.
  - Number of cycles = 1 only.
  - Power of soldering iron = 50W maximum.
- For ESD-sensitive devices, apply proper ESD precautions at the soldering station. Use only an ESD-safe soldering iron.
- Do not touch the LED package body with the soldering iron except for the soldering terminals because it may cause damage to the LED.
- Confirm beforehand whether the functionality and performance of the LED is affected by soldering with hand soldering.
- Keep the heat source at least 1.6 mm away from the LED body during soldering.
- Design an appropriate hole size to avoid problems during insertion.
- Cleaning agents from the ketone family (acetone, methyl ethylketone, and so on) and from the chlorinated hydrocarbon family (methylene chloride,

trichloroethylene, carbon tetrachloride, and so on) are not recommended for cleaning the LED displays. All of these various solvents attack or dissolve the encapsulating epoxies used to form the package of plastic LED parts.

- For the purpose of cleaning, wash with DI water only. The cleaning process should take place at room temperature only. Clear any water or moisture from the LED display immediately after washing.
- Use of *No clean* solder paste is recommended for soldering.

**Figure 13: Recommended Wave Soldering Profile**

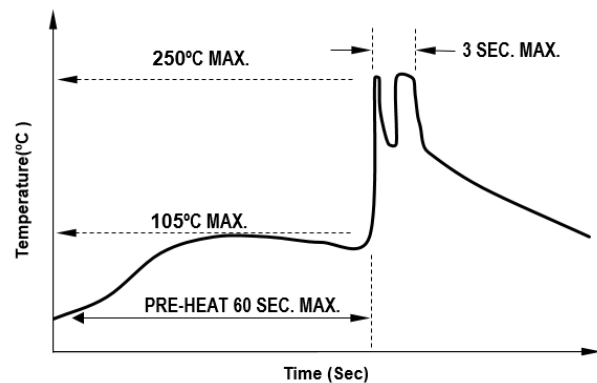

**NOTE:** Figure 13 refers to measurements with thermocouple mounted at the bottom of the PCB.

### Application Precautions

- The drive current of the LED must not exceed the maximum allowable limit across temperatures as stated in the data sheet. Constant current driving is recommended to ensure consistent performance.
- Circuit design must cater to the whole range of forward voltage ( $V_F$ ) of the LEDs to ensure the intended drive current can always be achieved.
- The LED exhibits slightly different characteristics at different drive currents, which may result in a larger variation of performance (such as intensity, wavelength, and forward voltage). Set the application current as close as possible to the test current to minimize these variations.
- The LED is not intended for reverse bias. Use other appropriate components for such purposes. When driving the LED in matrix form, ensure that the reverse bias voltage does not exceed the allowable limit of the LED.

- Avoid rapid change in ambient temperatures, especially in high-humidity environments, because they cause condensation on the LED.
- If the LED is intended to be used in a harsh or outdoor environment, protect the LED against damages caused by rain, water, dust, oil, corrosive gases, external mechanical stresses, and so on.

## Eye Safety Precautions

LEDs may pose optical hazards when in operation. Do not look directly at operating LEDs because it might be harmful to the eyes. For safety reasons, use appropriate shielding or personal protective equipment.

## Disclaimer

Broadcom's products and software are not specifically designed, manufactured, or authorized for sale as parts, components, or assemblies for the planning, construction, maintenance, or direct operation of a nuclear facility or for use in medical devices or applications. The customer is solely responsible, and waives all rights to make claims against Broadcom or its suppliers, for all loss, damage, expense, or liability in connection with such use.

Copyright © 2006–2022 Broadcom. All Rights Reserved. The term “Broadcom” refers to Broadcom Inc. and/or its subsidiaries. For more information, go to [www.broadcom.com](http://www.broadcom.com). All trademarks, trade names, service marks, and logos referenced herein belong to their respective companies.

Broadcom reserves the right to make changes without further notice to any products or data herein to improve reliability, function, or design. Information furnished by Broadcom is believed to be accurate and reliable. However, Broadcom does not assume any liability arising out of the application or use of this information, nor the application or use of any product or circuit described herein, neither does it convey any license under its patent rights nor the rights of others.

