

- Pletronics' THA3004-16.384 is a temperature compensated crystal oscillator
- Optional Voltage Control Function
- HCMOS output.
- The package is designed for high density surface mount designs.
- Tape and Reel packaging is available.
- Select Stratum-III frequencies available
- 5 x 7 mm LCC Ceramic Package

Pletronics Inc. certifies this device is in accordance with the RoHS 6/6 (2002/95/EC) and WEEE (2002/96/EC) directives.

Pletronics Inc. guarantees the device does not contain the following:

Cadmium, Hexavalent Chromium, Lead, Mercury, PBB's, PBDE's

Weight of the Device: 0.10 grams

Moisture Sensitivity Level: 1 As defined in J-STD-020D.1

Second Level Interconnect code: e4

Absolute Maximum Ratings:

Parameter	Unit
V _{CC} Supply Voltage	-0.5V to +6.5V
V _i Input Voltage	-0.5V to V _{CC} + 0.5V
V _o Output Voltage	-0.5V to V _{CC} + 0.5V

Thermal Characteristics

The maximum die or junction temperature is 155°C

The thermal resistance junction to board is 30 to 50°C/Watt depending on the solder pads, ground plane and construction of the PCB.

ESD Rating

Model	Minimum Voltage	Conditions
Human Body Model	1500	MIL-STD-883 Method 3115
Charged Device Model	1000	JESD 22-C101

Electrical Specification for specified Vcc over the specified temperature range

Item	Min	TYP	Max	Unit	Condition
Frequency Range		16.384		MHz	
Frequency Stability ¹	-0.28		+0.28	ppm	Vcontrol @ 1.50 volts (Fmax-Fmin)/2
Holdover	-0.37		+0.37	ppm	GR-1244-CORE
Frequency Calibration	-0.5		+0.5	ppm	Frequency offset at 25°C, 60 minutes after reflow
Frequency Stability / Supply	-0.1		+0.1	ppm	Load: 10K ohm // 10 pF & Vcc ± 5%
Load Sensitivity	-0.2		+0.2	ppm	±2% variation in magnitude from 10K ohm ±10% 10 pF
Long Term Stability (Aging)	-3.4		+3.4	ppb	After 15 years.
Output Waveform	CMOS				
Output V _{HIGH} as % of Supply	90			%V _S	Load: 10K ohm ± 10% // 10 pF ± 10%
Output V _{LOW} as % of Supply			10	%V _S	
T _{RISE} and T _{FALL} (10% to 90%)			6.5	nS	
Duty Cycle at 50% Supply	40	50	60	%	
Phase Noise	10 Hz	-	-90	-	Typical values for a 20.0 MHz oscillator at 25°C
	100 Hz	-	-115	-	
	1 kHz	-	-135	-	
	10 kHz	-	-145	-	
Jitter	-	-	1.7	pS	10 Hz to 1 MHz offset from carrier
V Supply Range V _{CC}	3.15	3.3	3.45	Volts	
Supply Current I _{CC}	-	-	7.0	mA	
Vcontrol Range	0.5		2.50	Volts	1.50 volts nominal
Frequency Pullability	± 9.2	± 10.0	-	ppm	
Linearity	-	0.05	2.0	%	In accordance with MIL-PRF-55310
Operating Temperature Range	-40		+85	°C	
Storage Temperature Range	-55		+95	°C	

Phase Noise:

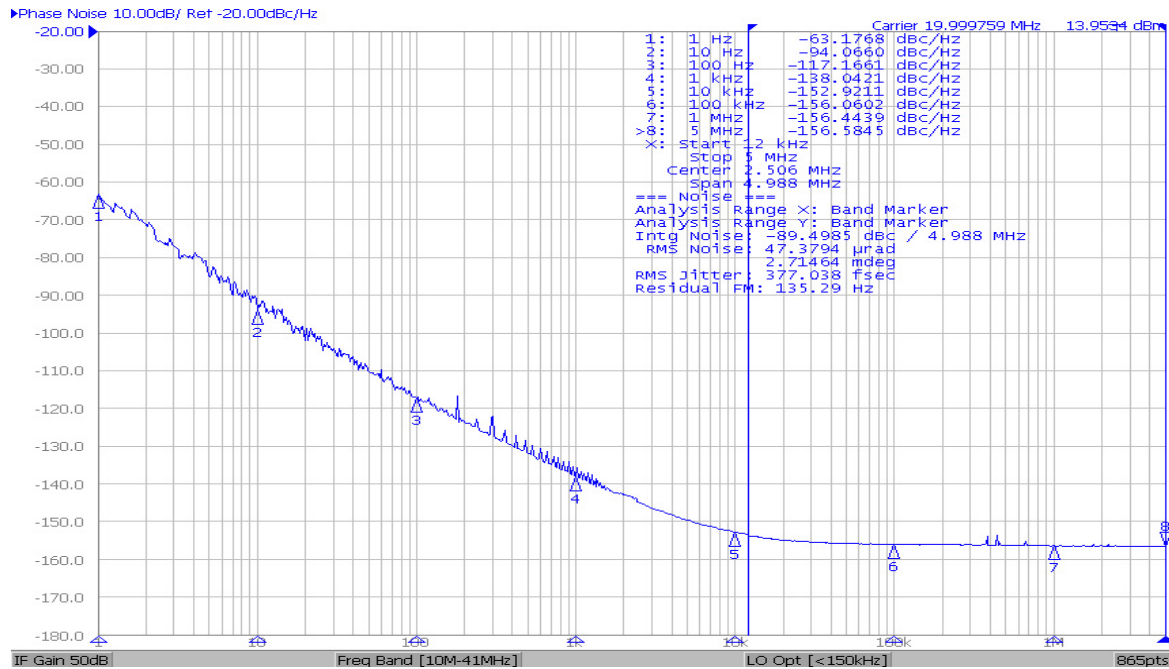

MTIE:

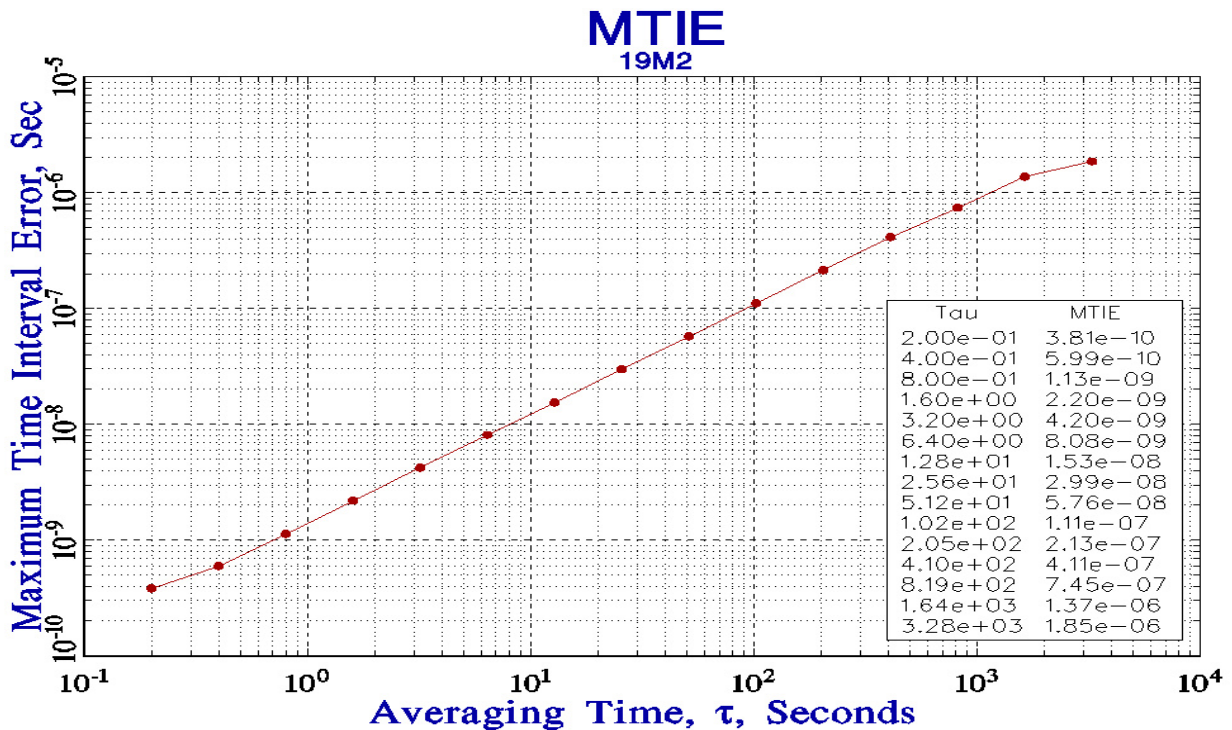

Reliability: Environmental Compliance

Parameter	Condition
Mechanical Shock	MIL-STD-883 Method 2002, Condition B
Vibration	MIL-STD-883 Method 2007, Condition A
Solderability	MIL-STD-883 Method 2003
Thermal Shock	MIL-STD-883 Method 1011, Condition A

Part Marking:



or



ffff.yww = frequency in MHz . Year week
 PLE = Pletronics
 xx.xxxx = internal code

Package Labeling

Label is 1" x 2.6" (25.4mm x 66.7mm)
 Font is Courier New
 Bar code is 39-Full ASCII

Label is 1" x 2.6" (25.4mm x 66.7mm)
 Font is Arial

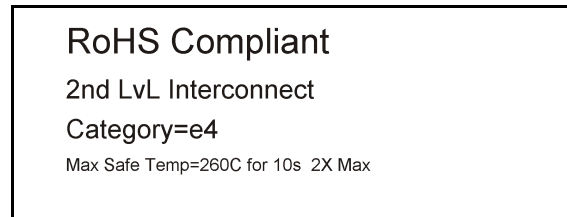
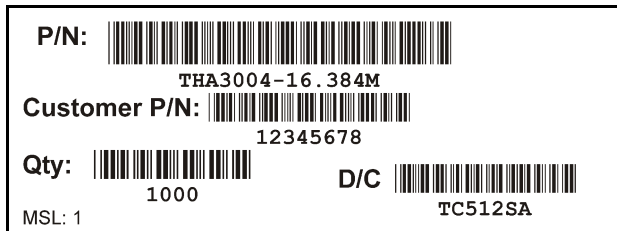

Mechanical:

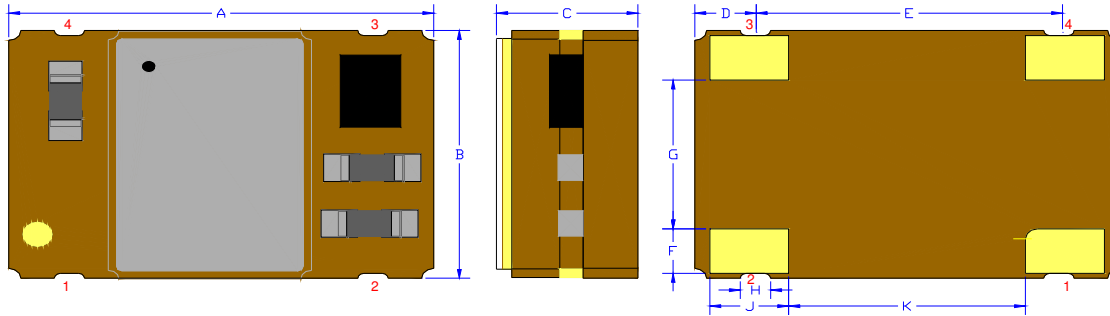

Not to Scale

Pad	Function	Note
1	Vcontrol Input	If this function is not specified, recommend connecting this pad to ground.
2	Ground (GND)	
3	Output	
4	Supply Voltage (V_{CC})	Recommend connecting appropriate power supply bypass capacitors as close as possible.

	Inches	mm
A	0.276 \pm 0.006	7.00 \pm 0.15
B	0.197 \pm 0.006	5.00 \pm 0.15
C	0.099 max	2.50 max
D ¹	0.039	1.00
E ¹	0.197	5.00
F ¹	0.025	0.90
G ¹	0.118	3.00
H ¹	0.020	0.50
J ¹	0.051	1.30
K ¹	0.154	3.90

¹ Typical dimensions

Contacts :

Gold 11.8 μ mches 0.3 μ m minimum over Nickel 50 to 350 μ mches 1.27 to 8.89 μ m

Reflow Cycle (typical for lead free processing)

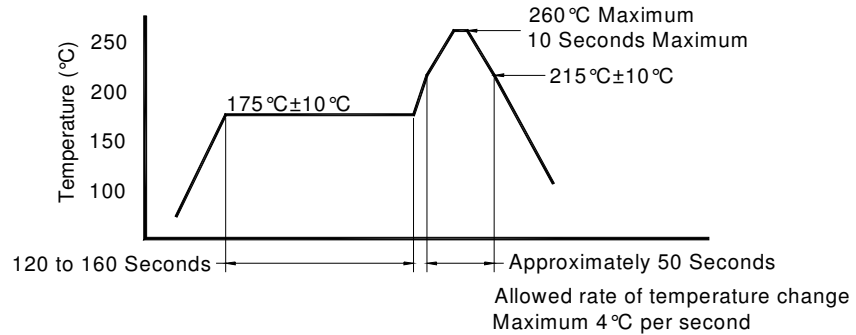

The part may be reflowed 2 times without degradation.

Tape and Reel: available for quantities of 250 to 1000 per reel, cut tape for < 250

Constant Dimensions Table 1								
Tape Size	D0	D1 Min	E1	P0	P2	S1 Min	T Max	T1 Max
8mm	1.5	1.0	1.75	4.0	2.0 ± 0.05	0.6	0.6	0.1
12mm		1.5			2.0 ± 0.1			
16mm	+0.1 -0.0	1.5	± 0.1	± 0.1	2.0 ± 0.1			
24mm		1.5						

Variable Dimensions Table 2							
Tape Size	B1 Max	E2 Min	F	P1	T2 Max	W Max	Ao, Bo & Ko
16 mm	12.1	14.25	7.5 ± 0.1	8.0 ± 0.1	8.0	16.3	Note 1

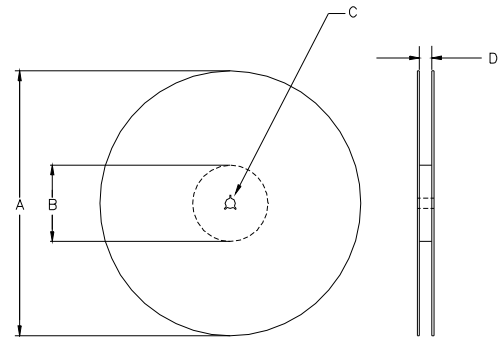

Note 1: Embossed cavity to conform to EIA-481-B Dimensions in mm Not to scale

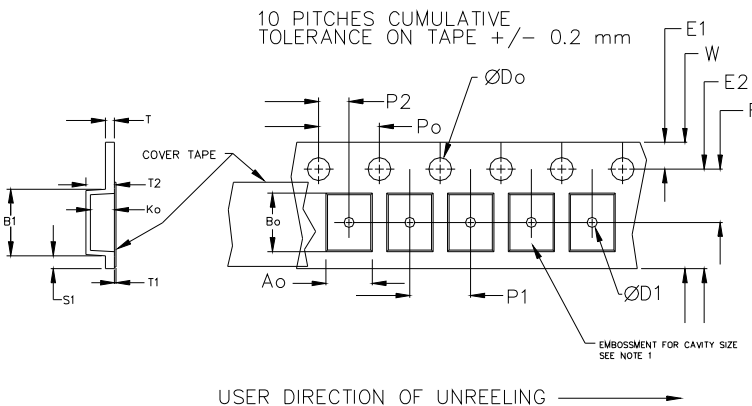

REEL DIMENSIONS					
A	inches	7.0	10.0	13.0	Tape Width
	mm	177.8	254.0	330.2	
B	inches	2.50	4.00	3.75	Tape Width
	mm	63.5	101.6	95.3	
C	mm	13.0 +0.5 / -0.2			Tape Width
D	mm	16.4 +2.0 -0.0	16.4 +2.0 -0.0	16.4 +2.0 -0.0	

Reel dimensions may vary from the above

IMPORTANT NOTICE

Pletronics Incorporated (PLE) reserves the right to make corrections, improvements, modifications and other changes to this product at anytime. PLE reserves the right to discontinue any product or service without notice. Customers are responsible for obtaining the latest relevant information before placing orders and should verify that such information is current and complete. All products are sold subject to PLE's terms and conditions of sale supplied at the time of order acknowledgment.

PLE warrants performance of this product to the specifications applicable at the time of sale in accordance with PLE's limited warranty. Testing and other quality control techniques are used to the extent PLE deems necessary to support this warranty. Except where mandated by specific contractual documents, testing of all parameters of each product is not necessarily performed.

PLE assumes no liability for application assistance or customer product design. Customers are responsible for their products and applications using PLE components. To minimize the risks associated with the customer products and applications, customers should provide adequate design and operating safeguards.

PLE products are not designed, intended, authorized or warranted to be suitable for use in life support applications, devices or systems or other critical applications that may involve potential risks of death, personal injury or severe property or environmental damage. Inclusion of PLE products in such applications is understood to be fully at the risk of the customer. Use of PLE products in such applications requires the written approval of an appropriate PLE officer. Questions concerning potential risk applications should be directed to PLE.

PLE does not warrant or represent that any license, either express or implied, is granted under any PLE patent right, copyright, artwork or other intellectual property right relating to any combination, machine or process which PLE product or services are used. Information published by PLE regarding third-party products or services does not constitute a license from PLE to use such products or services or a warranty or endorsement thereof. Use of such information may require a license from a third party under the patents or other intellectual property of the third party, or a license from PLE under the patents or other intellectual property of PLE.

Reproduction of information in PLE data sheets or web site is permissible only if the reproduction is without alteration and is accompanied by associated warranties, conditions, limitations and notices. Reproduction of this information with alteration is an unfair and deceptive business practice. PLE is not responsible or liable for such altered documents.

Resale of PLE products or services with statements different from or beyond the parameters stated by PLE for that product or service voids all express and implied warranties for the associated PLE product or service and is an unfair or deceptive business practice. PLE is not responsible for any such statements.

Contacting Pletronics Inc.

Pletronics Inc.
19013 36th Ave. West
Lynnwood, WA 98036-5761 USA

Tel: 425-776-1880
Fax: 425-776-2760
E-mail: ple-sales@pletronics.com
URL: www.pletronics.com

Copyright © 2011, Pletronics Inc.

Mouser Electronics

Authorized Distributor

Click to View Pricing, Inventory, Delivery & Lifecycle Information:

[Pletronics:](#)

[THA3004-16.384M](#)