

HDSP-740x Series, HDSP-750x Series, HDSP-780x Series, HDSP-A15x Series, HDSP-A40x Series

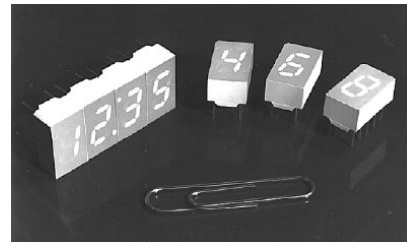

7.6 mm (0.3 inch) Micro Bright Seven Segment Displays

Data Sheet



Description

The 7.6 mm (0.3 inch) LED seven segment displays are designed for viewing distances up to 3 meters (10 feet). These devices use an industry standard size package and pinout. Both the numeric and ± 1 . overflow devices feature a right hand decimal point. All devices are available as either common anode or common cathode.

These displays are ideal for most applications. Pin-for-pin equivalent displays are also available in a low current design. The low current displays are ideal for portable applications. For additional information see the Low Current Seven Segment Displays.

Features

- Compact package
 - 0.300 x 0.500 inches
 - Leads on 2.54 mm (0.1 inch) centers
- Choice of colors
 - AlGaAs Red, High Efficiency Red, Yellow, Green, Orange
- Excellent appearance
 - Evenly lighted segments
 - Mitered corners on segments
 - Surface color gives optimum contrast
 - $\pm 50^\circ$ viewing angle
- Design flexibility
 - Common anode or common cathode
 - Right hand decimal point
 - ± 1 . Overflow Character
- Categorized for luminous intensity
 - Yellow and Green categorized for color
 - Use of like categories yields a uniform display
- High light output
- High peak current
- Excellent for long digit string multiplexing
- Intensity and color selection available
 - See Intensity and Color Selected Displays Data Sheet
- Sunlight viewable AlGaAs

Devices

Orange	AlGaAs ^[1]	HER ^[1]	Yellow ^[1]	Green ^[1]	Description	Package Drawing
HDSP-A401	HDSP-A151	HDSP-7501	HDSP-7401	HDSP-7801	Common Anode Right Hand Decimal	A
HDSP-A403	HDSP-A153	HDSP-7503	HDSP-7403	HDSP-7803	Common Cathode Right Hand Decimal	C
		HDSP-7507		HDSP-7807	CommonAnode ± 1 . Overflow	E
		HDSP-7508		HDSP-7808	Common Cathode ± 1 . Overflow	F

Note:

1. These displays are recommended for high ambient light operation. For low current operation, refer to the HDSP-A10X AlGaAs, HDSP-335X HER, HDSP-A80X Yellow, and HDSP-A90X Green data sheet.

Part Numbering System

5082 - X XX X - X X X XX
 HDSP - X XX X - X X X XX

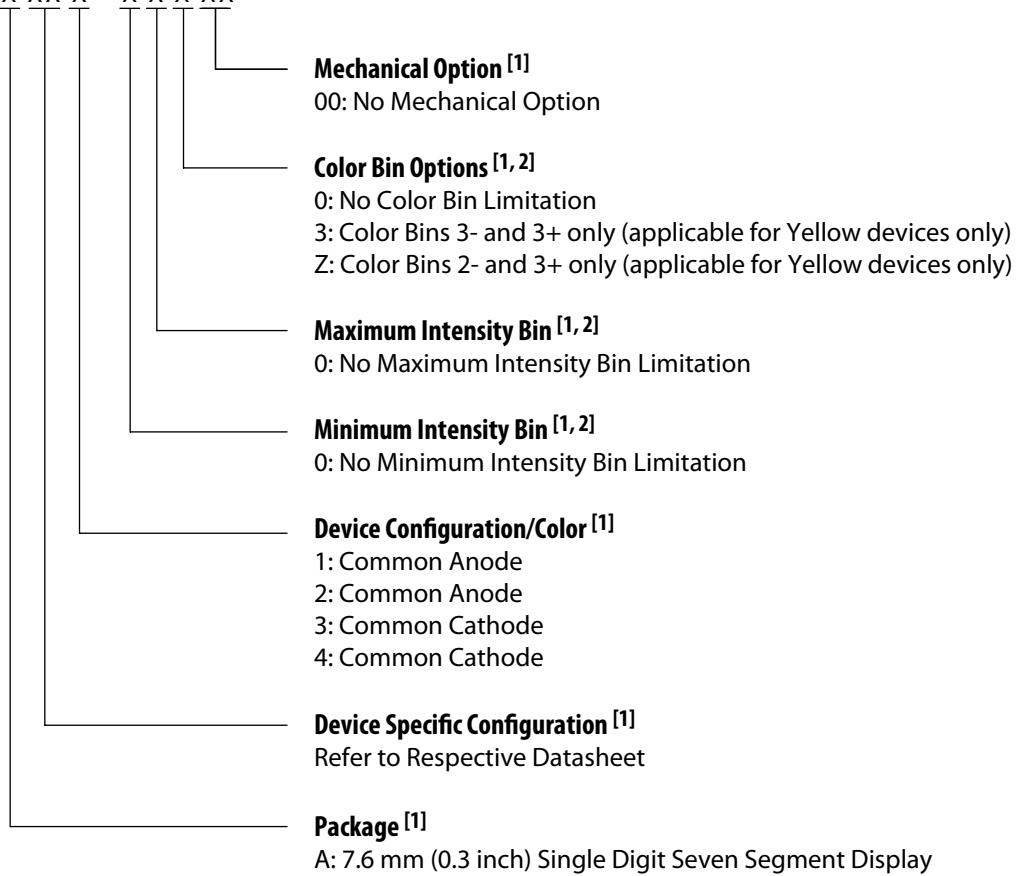

Notes:

1. For codes not listed in the figure above, please refer to the respective datasheet or contact your nearest Avago representative for details.
2. Bin options refer to shippable bins for a part number. Color and Intensity Bins are typically restricted to 1 bin per tube (exceptions may apply). Refer to respective datasheet for specific bin limit information.

Package Dimensions

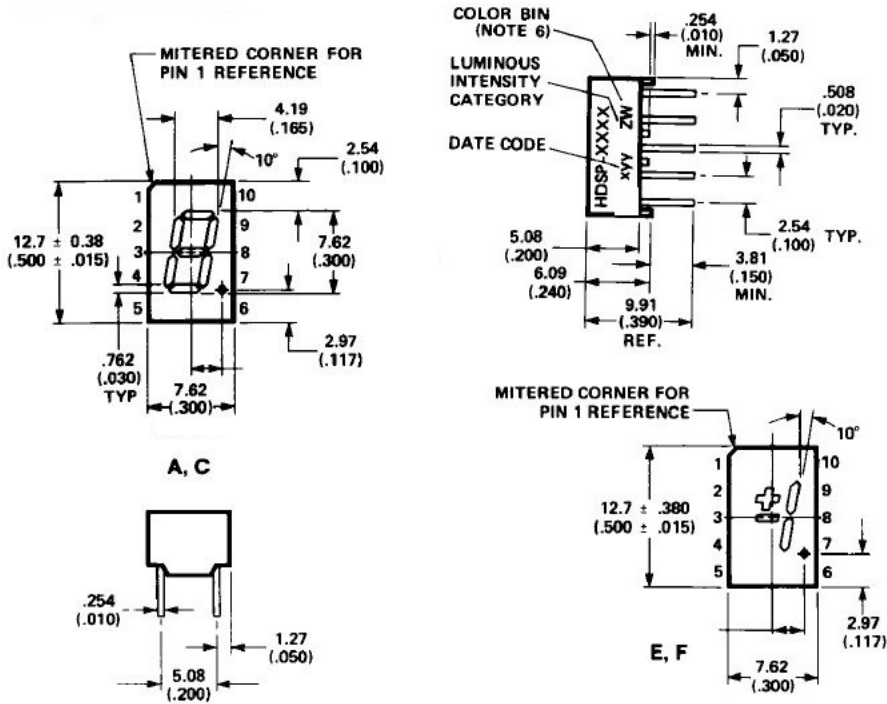

Notes:

1. All dimensions in millimeters (inches).
2. All untoleranced dimensions are for reference only.
3. Redundant anodes.
4. Redundant cathodes.
5. For HDSP-7400/7800 series product only.

Pin	FUNCTION			
	A	C	E	F
1	ANODE ^[3]	CATHODE ^[4]	ANODE ^[3]	CATHODE ^[5]
2	CATHODE f	ANODE f	CATHODE PLUS	ANODE PLUS
3	CATHODE g	ANODE g	CATHODE MINUS	ANODE MINUS
4	CATHODE e	ANODE e	NC	NC
5	CATHODE d	ANODE d	NC	NC
6	ANODE ^[3]	CATHODE ^[4]	ANODE ^[3]	CATHODE ^[4]
7	CATHODE DP	CATHODE DP	CATHODE DP	ANODE DP
8	CATHODE c	CATHODE c	CATHODE c	ANODE c
9	CATHODE b	CATHODE b	CATHODE b	ANODE b
10	CATHODE a	CATHODE a	NC	NC

Internal Circuit Diagram

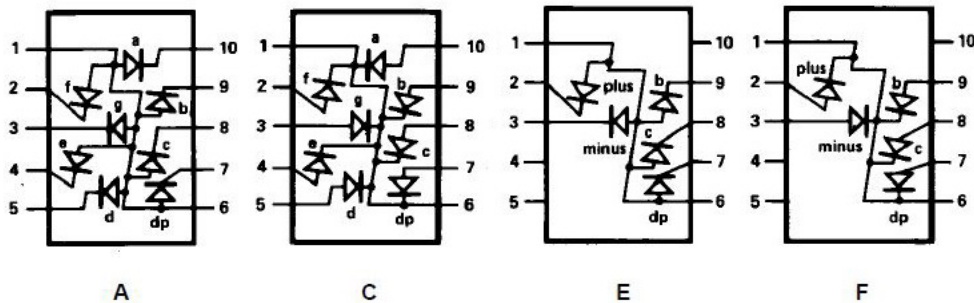

Absolute Maximum Ratings

Description	AlGaAs Red HDSP-A150 Series	HER/Orange HDSP-7500/ -A40X Series	Yellow HDSP-7400 Series	Green HDSP-7800 Series	Units
Average Power per Segment or DP	96	105	80	105	mW
Peak Forward Current per Segment or DP	160 ^[1]	90 ^[3]	60 ^[5]	90 ^[7]	mA
DC Forward Current per Segment or DP	40 ^[2]	30 ^[4]	20 ^[6]	30 ^[8]	mA
Operating Temperature Range	-20 to +100 ^[9]		-40 to +100		°C
Storage Temperature Range			-55 to +100		°C
Reverse Voltage* per segment or DP			3.0		V
Wave Soldering Temperature for 3 Seconds (1.59mm [0.063 in.] below Body)			250		°C

* reverse voltage is for LED testing purposes and is not recommended to be used as an application condition.

Notes:

- See Figure 1 to establish pulsed conditions.
- Derate above 46°C at 0.54 mA/°C.
- See Figure 6 to establish pulsed conditions.
- Derate above 53°C at 0.45 mA/°C.
- See Figure 7 to establish pulsed conditions.
- Derate above 81°C at 0.52 mA/°C.
- See Figure 8 to establish pulsed conditions.
- Derate above 39°C at 0.37 mA/°C.
- For operation below -20°C, contact your local Avago components sales office or an authorized distributor.

Electrical/Optical Characteristics at T_A = 25°C

AlGaAs Red

Device Series - HDSP-A15x

Parameter	Symbol	Min.	Typ.	Max.	Units	Test Conditions
Luminous Intensity/Segment ^[1,2,5] (Digit Average)	I _V	6.9	14.0		mcd	I _F = 20 mA
Forward Voltage/Segment or DP	V _F		1.8		V	I _F = 20 mA
			2.0	3.0	V	I _F = 100 mA
Peak Wavelength	λ _{PEAK}		645		nm	
Dominant Wavelength ^[3]	λ _d		637		nm	
Reverse Voltage/Segment or DP ^[4]	V _R	3.0	15.0		V	I _R = 100 μA
Temperature Coefficient of V _F /Segment or DP	ΔV _F /°C		-2		mV/°C	
Thermal Resistance LED Junction-to-Pin	Rθ _{J-PIN}		255		°C/W/Seg	

High Efficiency Red

Device Series - HDSP-750x

Parameter	Symbol	Min.	Typ.	Max.	Units	Test Conditions
Luminous Intensity/Segment ^[1,2,6] (Digit Average)	I _V		360	980	μcd	I _F = 5 mA
				5390		I _F = 20 mA
Forward Voltage/Segment or DP	V _F		2.0	2.5	V	I _F = 20 mA
Peak Wavelength	λ _{PEAK}		635		nm	
Dominant Wavelength ^[3]	λ _d		626		nm	
Reverse Voltage/Segment or DP ^[4]	V _R	3.0	30		V	I _R = 100 μA
Temperature Coefficient of V _F /Segment or DP	ΔV _F /°C		-2		mV/°C	
Thermal Resistance LED Junction-to-Pin	Rθ _{J-PIN}		200		°C/W/Seg	

Orange

Device Series - HDSP-A40x

Parameter	Symbol	Min.	Typ.	Max.	Units	Test Conditions
Luminous Intensity/Segment ^[1,2,6] (Digit Average)	I_V		0.70		mcd	$I_F = 5 \text{ mA}$
Forward Voltage/Segment or DP	V_F		2.0	2.5	V	$I_F = 20 \text{ mA}$
Peak Wavelength	λ_{PEAK}		600		nm	
Dominant Wavelength ^[3]	λ_d		603		nm	
Reverse Voltage/Segment or DP ^[4]	V_R	3.0	30		V	$I_R = 100 \mu\text{A}$
Temperature Coefficient of V_F /Segment or DP	$\Delta V_F/^\circ\text{C}$		-2		mV/°C	
Thermal Resistance LED Junction-to-Pin	$R\theta_{J-PIN}$		200		°C/W/Seg	

Yellow

Device Series - HDSP-740x

Parameter	Symbol	Min.	Typ.	Max.	Units	Test Conditions
Luminous Intensity/Segment ^[1,2,7] (Digit Average)	I_V	225	980		μcd	$I_F = 5 \text{ mA}$
			5390			$I_F = 20 \text{ mA}$
Forward Voltage/Segment or DP	V_F		2.2	2.5	V	$I_F = 20 \text{ mA}$
Peak Wavelength	λ_{PEAK}		583		nm	
Dominant Wavelength ^[3,9]	λ_d	581.5	586	592.5	nm	
Reverse Voltage/Segment or DP ^[4]	V_R	3.0	50.0		V	$I_R = 100 \mu\text{A}$
Temperature Coefficient of V_F /Segment or DP	$\Delta V_F/^\circ\text{C}$		-2		mV/°C	
Thermal Resistance LED Junction-to-Pin	$R\theta_{J-PIN}$		200		°C/W/Seg	

High Performance Green

Device Series - HDSP-780x

Parameter	Symbol	Min.	Typ.	Max.	Units	Test Conditions
Luminous Intensity/Segment ^[1,2,8] (Digit Average)	I_V	860	3000		μcd	$I_F = 10 \text{ mA}$
			6800			$I_F = 20 \text{ mA}$
Forward Voltage/Segment or DP	V_F		2.1	2.5	V	$I_F = 20 \text{ mA}$
Peak Wavelength	λ_{PEAK}		566		nm	
Dominant Wavelength ^[3,9]	λ_d		571	577	nm	
Reverse Voltage/Segment or DP ^[4]	V_R	3.0	50.0		V	$I_R = 100 \mu\text{A}$
Temperature Coefficient of V_F /Segment or DP	$\Delta V_F/^\circ\text{C}$		-2		mV/°C	
Thermal Resistance LED Junction-to-Pin	$R\theta_{J-PIN}$		200		°C/W/Seg	

Notes:

1. Case temperature of device immediately prior to the intensity measurement is 25°C.
2. The digits are categorized for luminous intensity. The intensity category is designated by a letter on the side of the package.
3. The dominant wavelength, λ_d , is derived from the CIE chromaticity diagram and is that single wavelength which defines the color of the device.
4. Typical specification for reference only. Do not exceed absolute maximum ratings.
5. For low current operation the AlGaAs HDSP-A101 series displays are recommended.
6. For low current operation the HER HDSP-7511 series displays are recommended.
7. For low current operation the Yellow HDSP-A801 series displays are recommended.
8. For low current operation the Green HDSP-A901 series displays are recommended.
9. The yellow (HDSP-7400) and Green (HDSP-7800) displays are categorized for dominant wavelength. The category is designated by a number adjacent to the luminous intensity category letter.

AlGaAs Red

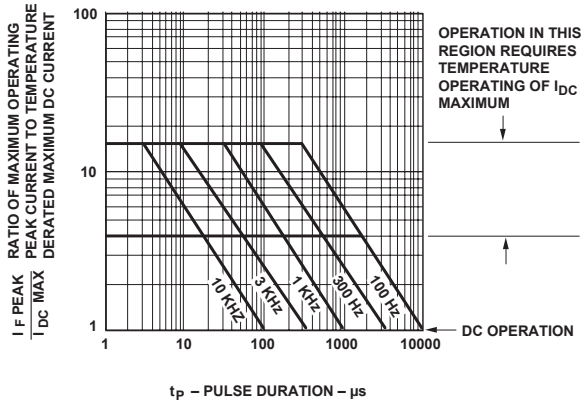

Figure 1. Maximum Allowed Peak Current vs. Pulse Duration – AlGaAs Red.

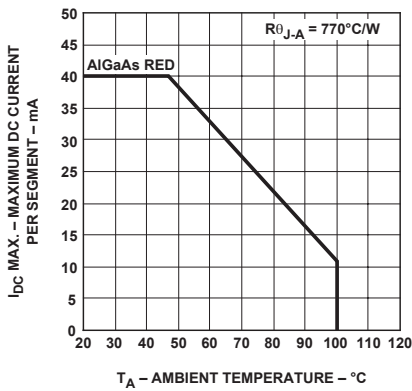

Figure 2. Maximum Allowable DC Current per Segment as a Function of Ambient Temperature.

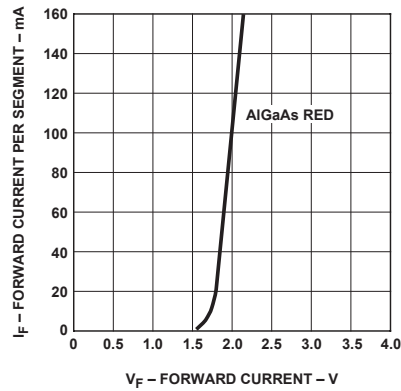

Figure 3. Forward Current vs. Forward Voltage.

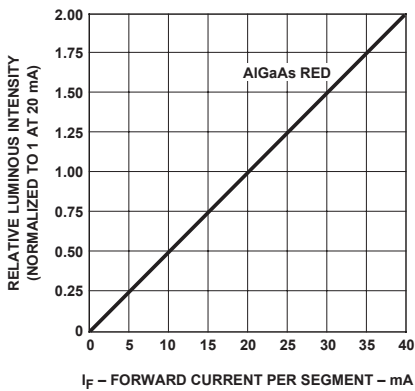

Figure 4. Relative Luminous Intensity vs. DC Forward Current.

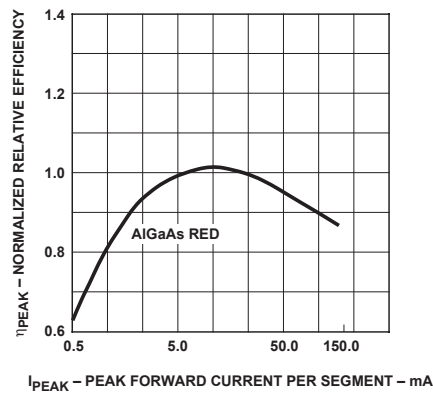

Figure 5. Relative Efficiency (Luminous Intensity per Unit Current) vs. Peak Current.

HER, Yellow, Green, Orange

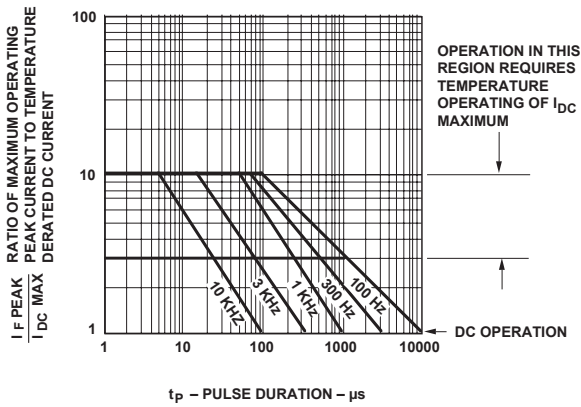

Figure 6. Maximum Tolerable Peak Current vs. Pulse Duration – HER, Orange.

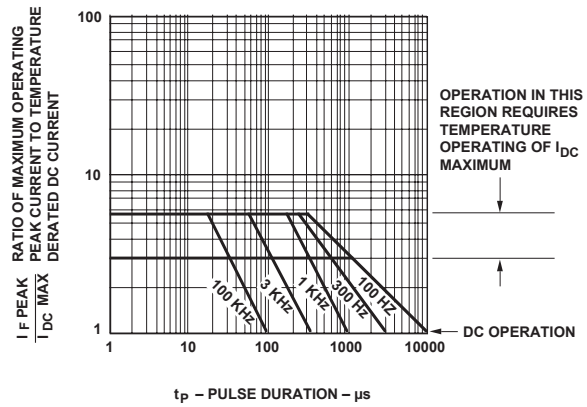

Figure 7. Maximum Tolerable Peak Current vs. Pulse Duration – Yellow.

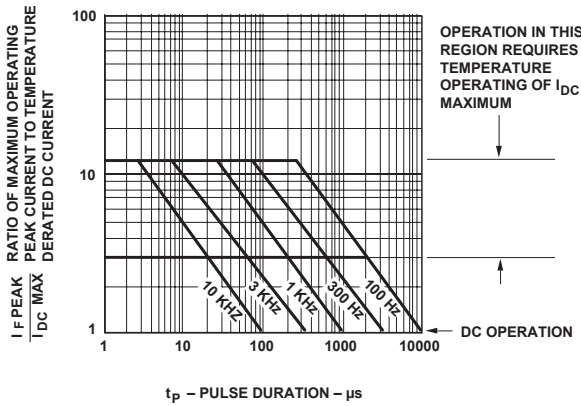

Figure 8. Allowable Peak Current vs. Pulse Duration – Green.

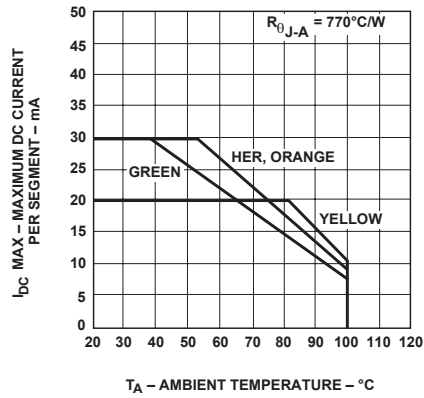

Figure 9. Maximum Allowable DC Current per Segment as a Function of Ambient Temperature.

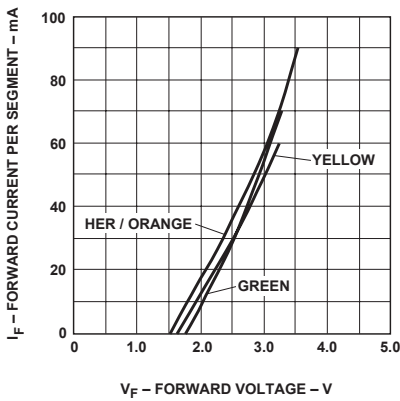

Figure 10. Forward Current vs. Forward Voltage Characteristics.

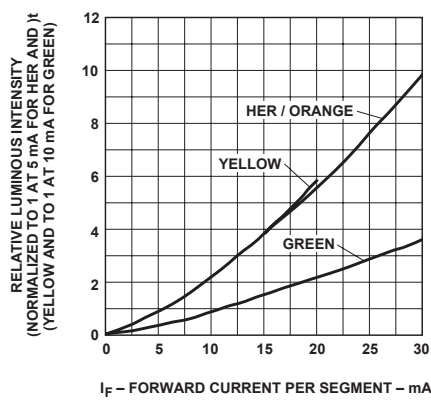

Figure 11. Relative Luminous Intensity vs. DC Forward Current.

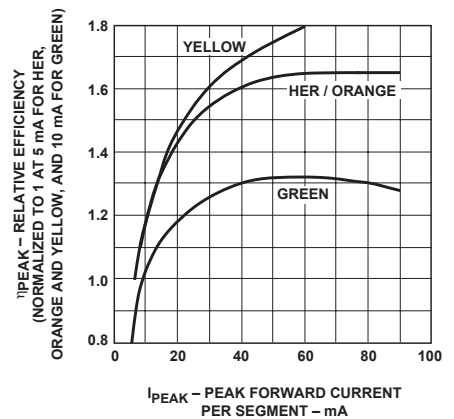

Figure 12. Relative Efficiency (Luminous Intensity per Unit Current) vs. Peak Current.

Intensity Bin Limits (mcd)

AlGaAs Red

HDSP-A15x		
IV Bin Category	Min.	Max.
M	7.07	13.00
N	10.60	19.40
O	15.90	29.20
P	23.90	43.80
Q	35.80	65.60

HER

HDSP-750x		
IV Bin Category	Min.	Max.
B	0.342	0.630
C	0.516	0.946
D	0.774	1.418
E	1.160	2.127
F	1.740	3.190
G	2.610	4.785
H	3.915	7.177

Orange

HDSP-A40x		
IV Bin Category	Min.	Max.
A	0.284	0.433
B	0.354	0.541
C	0.443	0.677
D	0.554	0.846
E	0.692	1.057
F	0.856	1.322
G	1.082	1.652
H	1.352	2.066
I	1.692	2.581
J	2.114	3.227
K	2.641	4.034
L	3.300	5.042
M	4.127	6.303
N	5.157	7.878

Yellow

HDSP-740x		
IV Bin Category	Min.	Max.
B	0.229	0.387
C	0.317	0.582
D	0.476	0.872
E	0.714	1.311
F	1.073	1.967
G	1.609	2.950
H	2.413	4.425

Green

HDSP-780x		
IV Bin Category	Min.	Max.
H	0.86	1.58
I	1.29	2.37
J	1.94	3.55
K	2.90	5.33
L	4.37	8.01

Color Categories

Color	Bin	Dominant Wavelength (nm)	
		Min.	Max.
Yellow	1	581.50	585.00
	3	584.00	587.50
	2	586.50	590.00
Green	4	589.00	592.50
	2	573.00	577.00
	3	570.00	574.00
	4	567.00	571.00
	5	564.00	568.00

Note:

All categories are established for classification of products. Products may not be available in all categories. Please contact your Avago representatives for further clarification/information.

Contrast Enhancement

For information on contrast enhancement, please see Application Note 1015.

Soldering/Cleaning

Cleaning agents from the ketone family (acetone, methyl ethyl ketone, etc.) and from the chlorinated hydrocarbon family (methylene chloride, trichloroethylene, carbon tetrachloride, etc.) are not recommended for cleaning LED parts. All of these various solvents attack or dissolve the encapsulating epoxies used to form the package of plastic LED parts.

For information on soldering LEDs, please refer to Application Note 1027.

For product information and a complete list of distributors, please go to our web site: www.avagotech.com