

# MUR180E, MUR1100E

## SWITCHMODE Power Rectifiers

### Ultrafast “E” Series with High Reverse Energy Capability

These state-of-the-art devices are designed for use in switching power supplies, inverters and as free wheeling diodes.

#### Features

- 10 mJoules Avalanche Energy Guaranteed
- Excellent Protection Against Voltage Transients in Switching Inductive Load Circuits
- Ultrafast 75 Nanosecond Recovery Time
- 175°C Operating Junction Temperature
- Low Forward Voltage
- Low Leakage Current
- High Temperature Glass Passivated Junction
- Reverse Voltage to 1000 V
- These are Pb-Free Devices\*

#### Mechanical Characteristics:

- Case: Epoxy, Molded
- Weight: 0.4 Gram (Approximately)
- Finish: All External Surfaces Corrosion Resistant and Terminal Leads are Readily Solderable
- Lead Temperature for Soldering Purposes: 260°C Max. for 10 Seconds
- Shipped in Plastic Bags; 1,000 per Bag
- Available Tape and Reel; 5,000 per Reel, by Adding a “RL” Suffix to the Part Number
- Polarity: Cathode Indicated by Polarity Band

#### MAXIMUM RATINGS

Rating	Symbol	Value	Unit
Peak Repetitive Reverse Voltage Working Peak Reverse Voltage DC Blocking Voltage	$V_{RRM}$ $V_{RWM}$ $V_R$	800 1000	V
Average Rectified Forward Current (Note 1) (Square Wave Mounting Method #3 Per Note 3)	$I_{F(AV)}$	1.0 @ $T_A = 95^\circ\text{C}$	A
Non-Repetitive Peak Surge Current (Surge applied at rated load conditions, halfwave, single phase, 60 Hz)	$I_{FSM}$	35	A
Operating Junction Temperature and Storage Temperature Range	$T_J, T_{stg}$	-65 to +175	°C

Stresses exceeding Maximum Ratings may damage the device. Maximum Ratings are stress ratings only. Functional operation above the Recommended Operating Conditions is not implied. Extended exposure to stresses above the Recommended Operating Conditions may affect device reliability.

1. Pulse Test: Pulse Width = 300  $\mu\text{s}$ , Duty Cycle  $\leq 2.0\%$ .

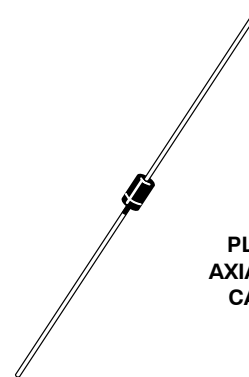
\*For additional information on our Pb-Free strategy and soldering details, please download the ON Semiconductor Soldering and Mounting Techniques Reference Manual, SOLDERRM/D.



ON Semiconductor®

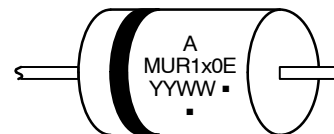
<http://onsemi.com>

### ULTRAFAST RECTIFIERS 1.0 AMPERES, 800–1000 VOLTS



PLASTIC  
AXIAL LEAD  
CASE 59

#### MARKING DIAGRAM



A = Assembly Location  
MUR1x0E = Device Code  
x 8 or 10  
Y = Year  
WW = Work Week  
▪ = Pb-Free Package  
(Note: Microdot may be in either location)

#### ORDERING INFORMATION

See detailed ordering and shipping information on page 2 of this data sheet.

# MUR180E, MUR1100E

## THERMAL CHARACTERISTICS

Characteristics	Symbol	Value	Unit
Maximum Thermal Resistance, Junction-to-Ambient	$R_{\theta JA}$	See Note 3	$^{\circ}\text{C}/\text{W}$

## ELECTRICAL CHARACTERISTICS

Characteristics	Symbol	Value	Unit
Maximum Instantaneous Forward Voltage (Note 2) ( $I_F = 1.0\text{ A}$ , $T_J = 150^{\circ}\text{C}$ ) ( $I_F = 1.0\text{ A}$ , $T_J = 25^{\circ}\text{C}$ )	$V_F$	1.50 1.75	V
Maximum Instantaneous Reverse Current (Note 2) (Rated dc Voltage, $T_J = 100^{\circ}\text{C}$ ) (Rated dc Voltage, $T_J = 25^{\circ}\text{C}$ )	$I_R$	600 10	$\mu\text{A}$
Maximum Reverse Recovery Time ( $I_F = 1.0\text{ A}$ , $di/dt = 50\text{ Amp}/\mu\text{s}$ ) ( $I_F = 0.5\text{ A}$ , $I_R = 1.0\text{ Amp}$ , $I_{REC} = 0.25\text{ A}$ )	$t_{rr}$	100 75	ns
Maximum Forward Recovery Time ( $I_F = 1.0\text{ A}$ , $di/dt = 100\text{ Amp}/\mu\text{s}$ , Recovery to 1.0 V)	$t_{fr}$	75	ns
Controlled Avalanche Energy (See Test Circuit in Figure 6)	$W_{AVAIL}$	10	mJ
Typical Peak Reverse Recovery Current ( $I_F = 1.0\text{ A}$ , $di/dt = 50\text{ A}/\mu\text{s}$ )	$I_{RM}$	1.7	A

2. Pulse Test: Pulse Width = 300  $\mu\text{s}$ , Duty Cycle  $\leq 2.0\%$ .

## ORDERING INFORMATION

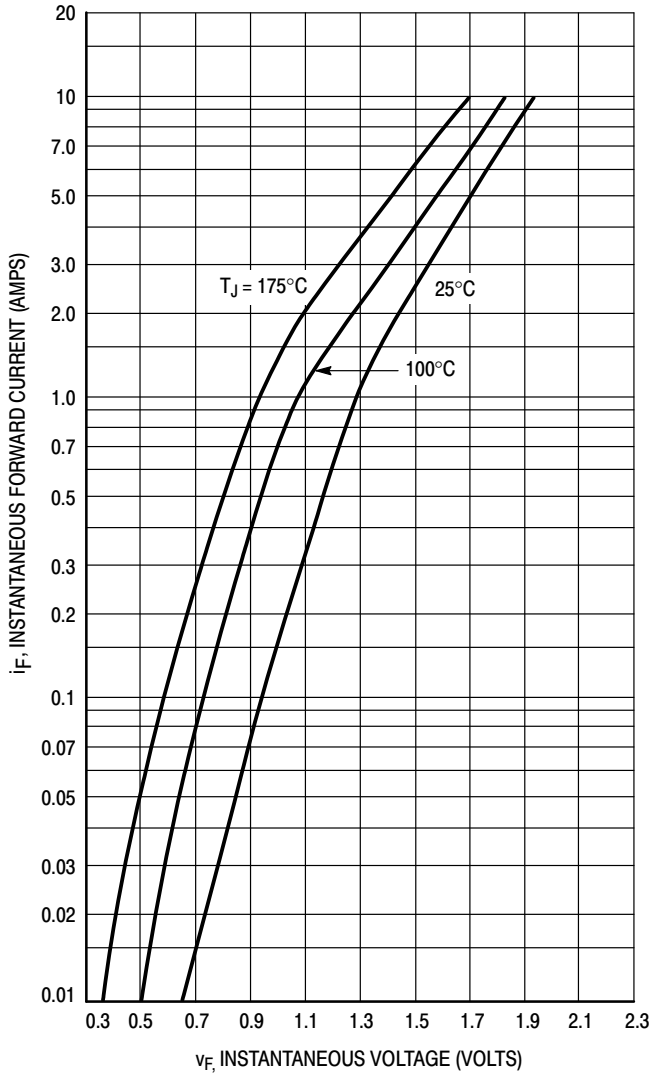
Device	Package	Shipping <sup>†</sup>
MUR180E	Axial Lead*	1000 Units / Bag
MUR180EG	Axial Lead*	
MUR180ERL	Axial Lead*	5000 / Tape & Reel
MUR180ERLG	Axial Lead*	
MUR1100E	Axial Lead*	1000 Units / Bag
MUR1100EG	Axial Lead*	
MUR1100ERL	Axial Lead*	5000 / Tape & Reel
MUR1100ERLG	Axial Lead*	

<sup>†</sup>For information on tape and reel specifications, including part orientation and tape sizes, please refer to our Tape and Reel Packaging Specifications Brochure, BRD8011/D.

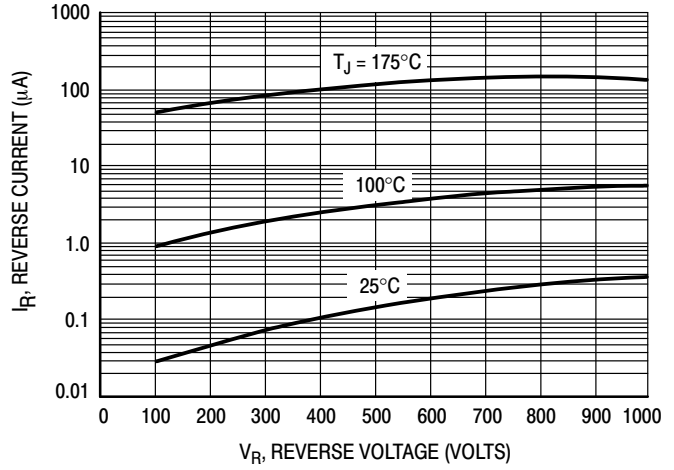
\*These packages are inherently Pb-Free.

# MUR180E, MUR1100E

## ELECTRICAL CHARACTERISTICS

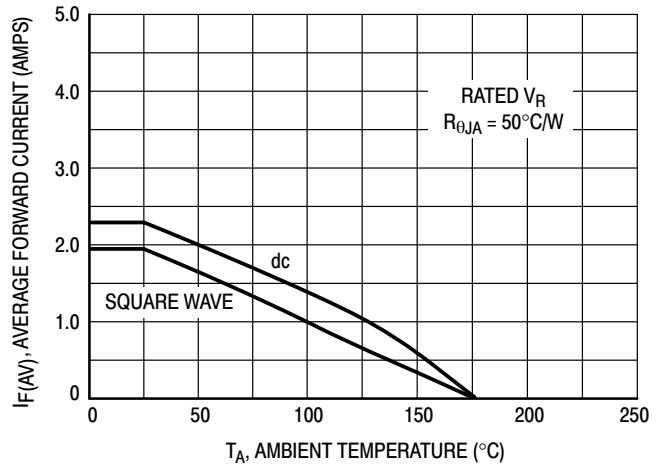


**Figure 1. Typical Forward Voltage**

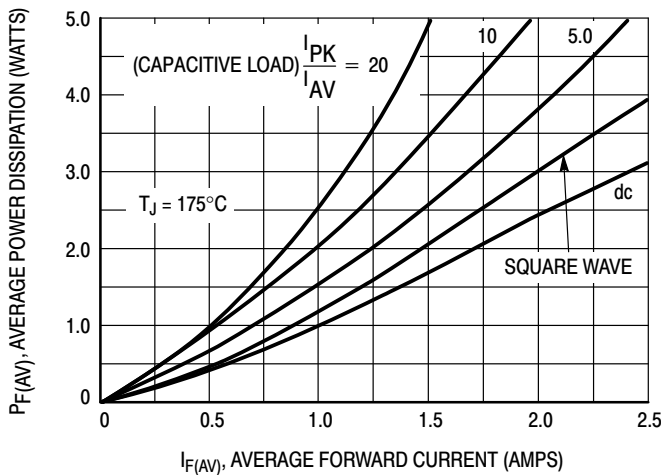


**Figure 2. Typical Reverse Current\***

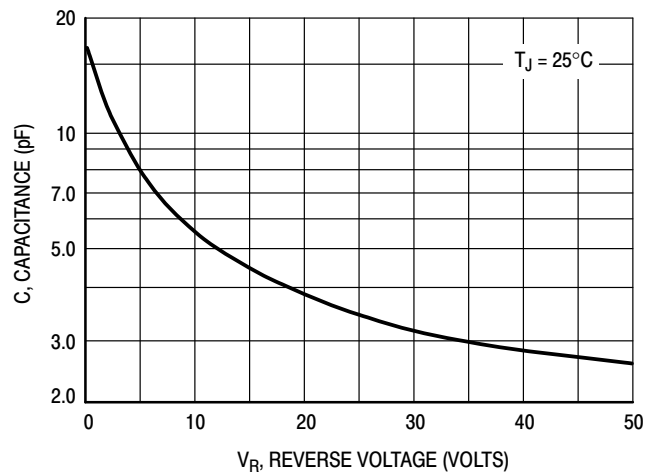
\* The curves shown are typical for the highest voltage device in the grouping. Typical reverse current for lower voltage selections can be estimated from these same curves if  $V_R$  is sufficiently below rated  $V_R$ .



**Figure 3. Current Derating  
(Mounting Method #3 Per Note 3)**



**Figure 4. Power Dissipation**



**Figure 5. Typical Capacitance**

# MUR180E, MUR1100E

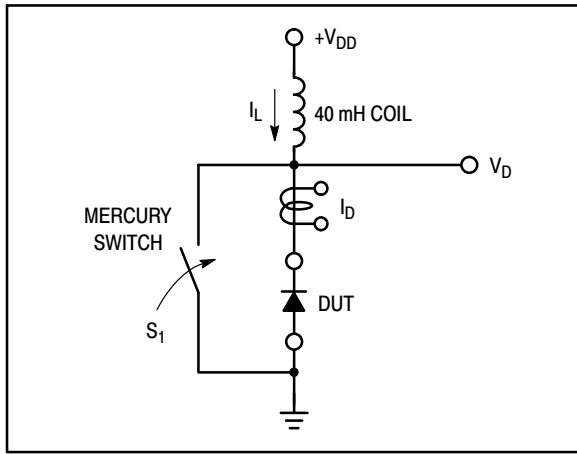


Figure 6. Test Circuit

The unclamped inductive switching circuit shown in Figure 6 was used to demonstrate the controlled avalanche capability of the new “E” series Ultrafast rectifiers. A mercury switch was used instead of an electronic switch to simulate a noisy environment when the switch was being opened.

When  $S_1$  is closed at  $t_0$  the current in the inductor  $I_L$  ramps up linearly; and energy is stored in the coil. At  $t_1$  the switch is opened and the voltage across the diode under test begins to rise rapidly, due to  $di/dt$  effects, when this induced voltage reaches the breakdown voltage of the diode, it is clamped at  $BV_{DUT}$  and the diode begins to conduct the full load current which now starts to decay linearly through the diode, and goes to zero at  $t_2$ .

By solving the loop equation at the point in time when  $S_1$  is opened; and calculating the energy that is transferred to the diode it can be shown that the total energy transferred is equal to the energy stored in the inductor plus a finite amount of energy from the  $V_{DD}$  power supply while the diode is in breakdown (from  $t_1$  to  $t_2$ ) minus any losses due to finite

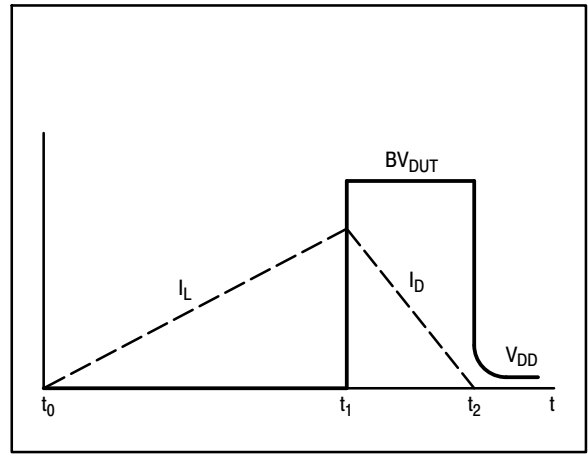


Figure 7. Current-Voltage Waveforms

component resistances. Assuming the component resistive elements are small Equation (1) approximates the total energy transferred to the diode. It can be seen from this equation that if the  $V_{DD}$  voltage is low compared to the breakdown voltage of the device, the amount of energy contributed by the supply during breakdown is small and the total energy can be assumed to be nearly equal to the energy stored in the coil during the time when  $S_1$  was closed, Equation (2).

The oscilloscope picture in Figure 8, shows the information obtained for the MUR8100E (similar die construction as the MUR1100E Series) in this test circuit conducting a peak current of one ampere at a breakdown voltage of 1300 V, and using Equation (2) the energy absorbed by the MUR8100E is approximately 20 mjoules.

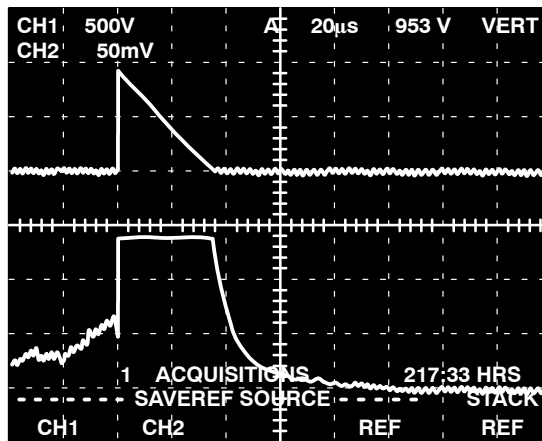
Although it is not recommended to design for this condition, the new “E” series provides added protection against those unforeseen transient viruses that can produce unexplained random failures in unfriendly environments.

EQUATION (1):

$$W_{AVAL} \approx \frac{1}{2} L I_{LPK}^2 \left( \frac{BV_{DUT}}{BV_{DUT} - V_{DD}} \right)$$

EQUATION (2):

$$W_{AVAL} \approx \frac{1}{2} L I_{LPK}^2$$



CHANNEL 2:  
 $I_L$   
0.5 AMPS/DIV.

CHANNEL 1:  
 $V_{DUT}$   
500 VOLTS/DIV.

TIME BASE:  
20  $\mu$ s/DIV.

Figure 8. Current-Voltage Waveforms

# MUR180E, MUR1100E

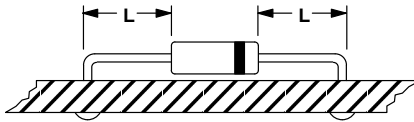
## NOTE 3 – AMBIENT MOUNTING DATA

Data shown for thermal resistance, junction-to-ambient ( $R_{\theta JA}$ ) for the mountings shown is to be used as typical guideline values for preliminary engineering or in case the tie point temperature cannot be measured.

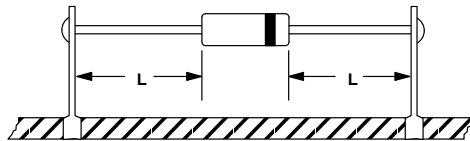
### TYPICAL VALUES FOR $R_{\theta JA}$ IN STILL AIR

Mounting Method	$R_{\theta JA}$	Lead Length, L			Units
		1/8	1/4	1/2	
1		52	65	72	$^{\circ}\text{C}/\text{W}$
2		67	80	87	$^{\circ}\text{C}/\text{W}$
3		50			$^{\circ}\text{C}/\text{W}$

#### MOUNTING METHOD 1

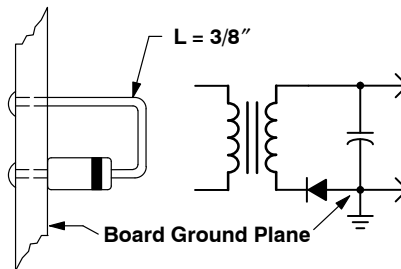


#### MOUNTING METHOD 2



#### Vector Pin Mounting

#### MOUNTING METHOD 3

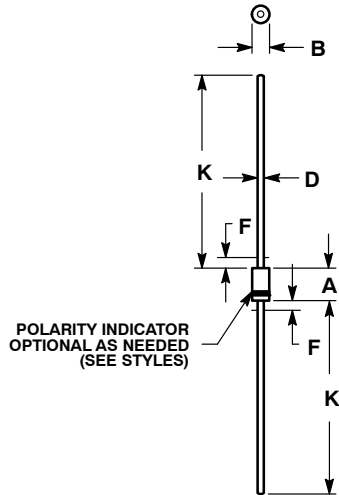


#### P.C. Board with 1-1/2" X 1-1/2" Copper Surface

# MUR180E, MUR1100E

## PACKAGE DIMENSIONS

### AXIAL LEAD CASE 59-10 ISSUE U




#### NOTES:

1. DIMENSIONING AND TOLERANCING PER ANSI Y14.5M, 1982.
2. CONTROLLING DIMENSION: INCH.
3. ALL RULES AND NOTES ASSOCIATED WITH JEDEC DO-41 OUTLINE SHALL APPLY
4. POLARITY DENOTED BY CATHODE BAND.
5. LEAD DIAMETER NOT CONTROLLED WITHIN F DIMENSION.

DIM	INCHES		MILLIMETERS	
	MIN	MAX	MIN	MAX
A	0.161	0.205	4.10	5.20
B	0.079	0.106	2.00	2.70
D	0.028	0.034	0.71	0.86
F	----	0.050	----	1.27
K	1.000	----	25.40	----

#### STYLE 1:

1. CATHODE (POLARITY BAND)
2. ANODE

ON Semiconductor and  are registered trademarks of Semiconductor Components Industries, LLC (SCILLC). SCILLC owns the rights to a number of patents, trademarks, copyrights, trade secrets, and other intellectual property. A listing of SCILLC's product/patent coverage may be accessed at [www.onsemi.com/site/pdf/Patent-Marking.pdf](http://www.onsemi.com/site/pdf/Patent-Marking.pdf). SCILLC reserves the right to make changes without further notice to any products herein. SCILLC makes no warranty, representation or guarantee regarding the suitability of its products for any particular purpose, nor does SCILLC assume any liability arising out of the application or use of any product or circuit, and specifically disclaims any and all liability, including without limitation special, consequential or incidental damages. "Typical" parameters which may be provided in SCILLC data sheets and/or specifications can and do vary in different applications and actual performance may vary over time. All operating parameters, including "Typicals" must be validated for each customer application by customer's technical experts. SCILLC does not convey any license under its patent rights nor the rights of others. SCILLC products are not designed, intended, or authorized for use as components in systems intended for surgical implant into the body, or other applications intended to support or sustain life, or for any other application in which the failure of the SCILLC product could create a situation where personal injury or death may occur. Should Buyer purchase or use SCILLC products for any such unintended or unauthorized application, Buyer shall indemnify and hold SCILLC and its officers, employees, subsidiaries, affiliates, and distributors harmless against all claims, costs, damages, and expenses, and reasonable attorney fees arising out of, directly or indirectly, any claim of personal injury or death associated with such unintended or unauthorized use, even if such claim alleges that SCILLC was negligent regarding the design or manufacture of the part. SCILLC is an Equal Opportunity/Affirmative Action Employer. This literature is subject to all applicable copyright laws and is not for resale in any manner.

## PUBLICATION ORDERING INFORMATION

### LITERATURE FULFILLMENT:

Literature Distribution Center for ON Semiconductor  
P.O. Box 5163, Denver, Colorado 80217 USA  
Phone: 303-675-2175 or 800-344-3860 Toll Free USA/Canada  
Fax: 303-675-2176 or 800-344-3867 Toll Free USA/Canada  
Email: [orderlit@onsemi.com](mailto:orderlit@onsemi.com)

N. American Technical Support: 800-282-9855 Toll Free  
USA/Canada  
Europe, Middle East and Africa Technical Support:  
Phone: 421 33 790 2910  
Japan Customer Focus Center  
Phone: 81-3-5817-1050

ON Semiconductor Website: [www.onsemi.com](http://www.onsemi.com)

Order Literature: <http://www.onsemi.com/orderlit>

For additional information, please contact your local  
Sales Representative

# Mouser Electronics

Authorized Distributor

Click to View Pricing, Inventory, Delivery & Lifecycle Information:

[ON Semiconductor:](#)

[MUR1100E](#) [MUR1100EG](#) [MUR1100ERL](#) [MUR1100ERLG](#) [MUR180E](#) [MUR180EG](#) [MUR180ERL](#) [MUR180ERLG](#)