



RF Power Field Effect Transistors

N-Channel Enhancement-Mode Lateral MOSFETs

Designed for broadband commercial and industrial applications with frequencies up to 1000 MHz. The high gain and broadband performance of these devices make them ideal for large-signal, common-source amplifier applications in 28 volt base station equipment.

- Typical Two-Tone Performance at 945 MHz, 28 Volts
 - Output Power — 45 Watts PEP
 - Power Gain — 18.8 dB
 - Efficiency — 42%
 - IMD — -32 dBc
- Capable of Handling 10:1 VSWR, @ 28 Vdc, 945 MHz, 45 Watts CW Output Power

Features

- Integrated ESD Protection
- Designed for Maximum Gain and Insertion Phase Flatness
- Excellent Thermal Stability
- Characterized with Series Equivalent Large-Signal Impedance Parameters
- Low Gold Plating Thickness on Leads. L Suffix Indicates 40μ" Nominal.
- RoHS Compliant
- In Tape and Reel. R1 Suffix = 500 Units per 32 mm, 13 inch Reel.

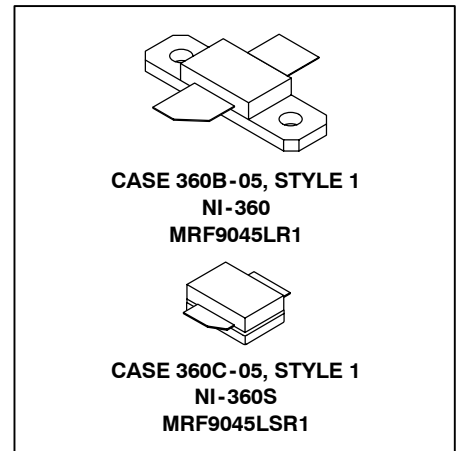
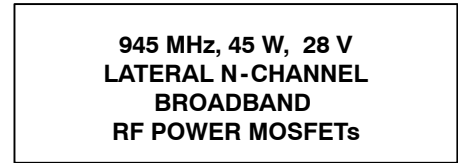
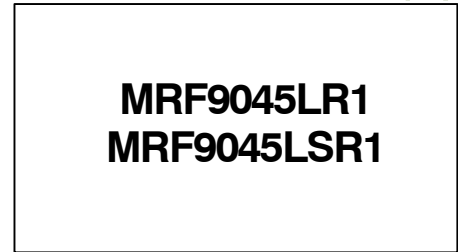

Table 1. Maximum Ratings

Rating	Symbol	Value	Unit
Drain-Source Voltage	V _{DSS}	- 0.5, +65	Vdc
Gate-Source Voltage	V _{GS}	- 0.5, + 15	Vdc
Total Device Dissipation @ T _C = 25°C Derate above 25°C	MRF9045LR1 MRF9045LSR1 P _D	125 0.71 175 1	W W/°C
Storage Temperature Range	T _{stg}	- 65 to +150	°C
Case Operating Temperature	T _C	150	°C
Operating Junction Temperature	T _J	200	°C

Table 2. Thermal Characteristics

Characteristic	Symbol	Value	Unit
Thermal Resistance, Junction to Case	MRF9045LR1 MRF9045LSR1 R _{θJC}	1.4 1.0	°C/W

Table 3. ESD Protection Characteristics

Test Conditions	Class
Human Body Model	1 (Minimum)
Machine Model	M1 (Minimum)

Table 4. Electrical Characteristics ($T_C = 25^\circ\text{C}$ unless otherwise noted)

Characteristic	Symbol	Min	Typ	Max	Unit
Off Characteristics					
Zero Gate Voltage Drain Leakage Current ($V_{DS} = 65\text{ Vdc}$, $V_{GS} = 0\text{ Vdc}$)	I_{DSS}	—	—	10	μAdc
Zero Gate Voltage Drain Leakage Current ($V_{DS} = 28\text{ Vdc}$, $V_{GS} = 0\text{ Vdc}$)	I_{DSS}	—	—	1	μAdc
Gate-Source Leakage Current ($V_{GS} = 5\text{ Vdc}$, $V_{DS} = 0\text{ Vdc}$)	I_{GSS}	—	—	1	μAdc
On Characteristics					
Gate Threshold Voltage ($V_{DS} = 10\text{ Vdc}$, $I_D = 150\ \mu\text{Adc}$)	$V_{GS(th)}$	2	3	4	Vdc
Gate Quiescent Voltage ($V_{DS} = 28\text{ Vdc}$, $I_D = 350\ \text{mAdc}$)	$V_{GS(Q)}$	—	3.7	—	Vdc
Drain-Source On-Voltage ($V_{GS} = 10\text{ Vdc}$, $I_D = 1\ \text{Adc}$)	$V_{DS(on)}$	—	0.19	0.4	Vdc
Forward Transconductance ($V_{DS} = 10\text{ Vdc}$, $I_D = 3\ \text{Adc}$)	g_{fs}	—	4	—	S
Dynamic Characteristics					
Input Capacitance ($V_{DS} = 28\text{ Vdc} \pm 30\ \text{mV(rms)ac}$ @ 1 MHz, $V_{GS} = 0\text{ Vdc}$)	C_{iss}	—	69	—	pF
Output Capacitance ($V_{DS} = 28\text{ Vdc} \pm 30\ \text{mV(rms)ac}$ @ 1 MHz, $V_{GS} = 0\text{ Vdc}$)	C_{oss}	—	37	—	pF
Reverse Transfer Capacitance ($V_{DS} = 28\text{ Vdc} \pm 30\ \text{mV(rms)ac}$ @ 1 MHz, $V_{GS} = 0\text{ Vdc}$)	C_{rss}	—	1.5	—	pF

(continued)

Table 4. Electrical Characteristics ($T_C = 25^\circ\text{C}$ unless otherwise noted) (continued)

Characteristic	Symbol	Min	Typ	Max	Unit
Functional Tests (In Freescale Test Fixture, 50 ohm system)					
Two-Tone Common-Source Amplifier Power Gain ($V_{DD} = 28\text{ Vdc}$, $P_{out} = 45\text{ W PEP}$, $I_{DQ} = 350\text{ mA}$, $f_1 = 945.0\text{ MHz}$, $f_2 = 945.1\text{ MHz}$)	G_{ps}	17	18.8	—	dB
Two-Tone Drain Efficiency ($V_{DD} = 28\text{ Vdc}$, $P_{out} = 45\text{ W PEP}$, $I_{DQ} = 350\text{ mA}$, $f_1 = 945.0\text{ MHz}$, $f_2 = 945.1\text{ MHz}$)	η	38	42	—	%
3rd Order Intermodulation Distortion ($V_{DD} = 28\text{ Vdc}$, $P_{out} = 45\text{ W PEP}$, $I_{DQ} = 350\text{ mA}$, $f_1 = 945.0\text{ MHz}$, $f_2 = 945.1\text{ MHz}$)	IMD	—	-32	-28	dBc
Input Return Loss ($V_{DD} = 28\text{ Vdc}$, $P_{out} = 45\text{ W PEP}$, $I_{DQ} = 350\text{ mA}$, $f_1 = 945.0\text{ MHz}$, $f_2 = 945.1\text{ MHz}$)	IRL	—	-14	-9	dB
Two-Tone Common-Source Amplifier Power Gain ($V_{DD} = 28\text{ Vdc}$, $P_{out} = 45\text{ W PEP}$, $I_{DQ} = 350\text{ mA}$, $f_1 = 930.0\text{ MHz}$, $f_2 = 930.1\text{ MHz}$ and $f_1 = 960.0\text{ MHz}$, $f_2 = 960.1\text{ MHz}$)	G_{ps}	—	18.5	—	dB
Two-Tone Drain Efficiency ($V_{DD} = 28\text{ Vdc}$, $P_{out} = 45\text{ W PEP}$, $I_{DQ} = 350\text{ mA}$, $f_1 = 930.0\text{ MHz}$, $f_2 = 930.1\text{ MHz}$ and $f_1 = 960.0\text{ MHz}$, $f_2 = 960.1\text{ MHz}$)	η	—	41	—	%
3rd Order Intermodulation Distortion ($V_{DD} = 28\text{ Vdc}$, $P_{out} = 45\text{ W PEP}$, $I_{DQ} = 350\text{ mA}$, $f_1 = 930.0\text{ MHz}$, $f_2 = 930.1\text{ MHz}$ and $f_1 = 960.0\text{ MHz}$, $f_2 = 960.1\text{ MHz}$)	IMD	—	-33	—	dBc
Input Return Loss ($V_{DD} = 28\text{ Vdc}$, $P_{out} = 45\text{ W PEP}$, $I_{DQ} = 350\text{ mA}$, $f_1 = 930.0\text{ MHz}$, $f_2 = 930.1\text{ MHz}$ and $f_1 = 960.0\text{ MHz}$, $f_2 = 960.1\text{ MHz}$)	IRL	—	13	—	dB
Power Output, 1 dB Compression Point ($V_{DD} = 28\text{ Vdc}$, $P_{out} = 45\text{ W CW}$, $I_{DQ} = 350\text{ mA}$, $f_1 = 945.0\text{ MHz}$)	P_{1dB}	—	55	—	W
Common-Source Amplifier Power Gain ($V_{DD} = 28\text{ Vdc}$, $P_{out} = 45\text{ W CW}$, $I_{DQ} = 350\text{ mA}$, $f_1 = 945.0\text{ MHz}$)	G_{ps}	—	18	—	dB
Drain Efficiency ($V_{DD} = 28\text{ Vdc}$, $P_{out} = 45\text{ W CW}$, $I_{DQ} = 350\text{ mA}$, $f_1 = 945.0\text{ MHz}$)	η	—	60	—	%

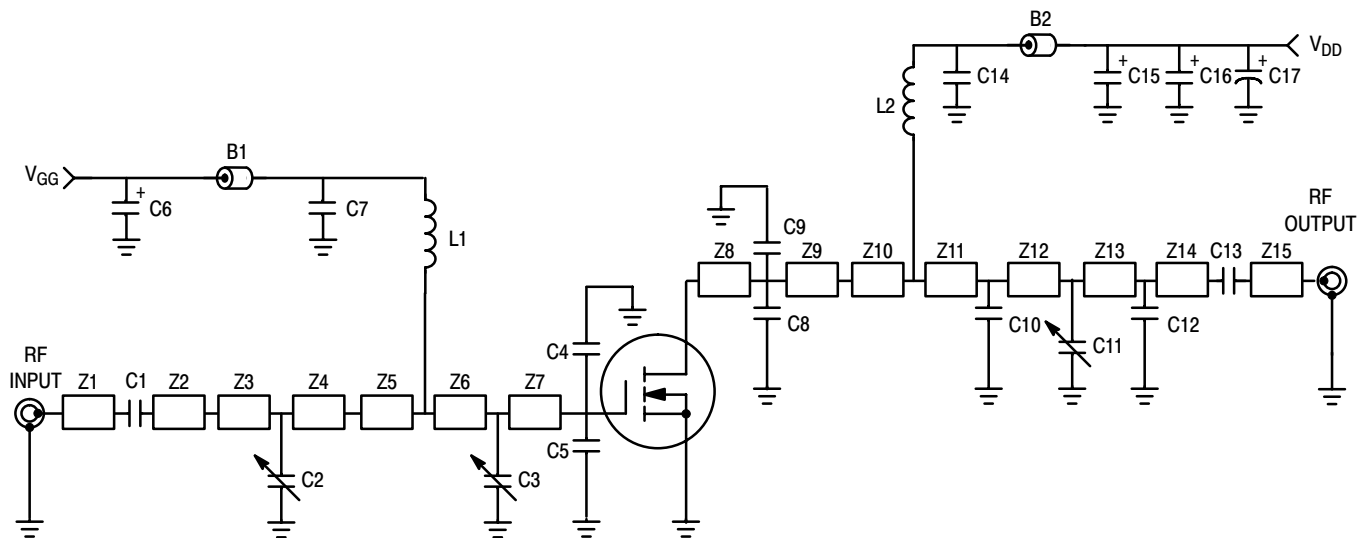

B1	Short Ferrite Bead Surface Mount	Z4	0.360" x 0.320" Microstrip
B2	Long Ferrite Bead Surface Mount	Z5	0.240" x 0.320" x 0.620", Taper
C1, C7, C13, C14	47 pF Chip Capacitors	Z6	0.140" x 0.620" Microstrip
C2, C3, C11	0.8-8.0 pF Gigatrim Variable Trim Capacitors	Z7	0.510" x 0.620" Microstrip
C4, C5, C8, C9	10 pF Chip Capacitors	Z8	0.330" x 0.320" Microstrip
C6, C15, C16	10 μ F, 35 V Tantalum Surface Mount Chip Capacitors	Z9	0.140" x 0.320" Microstrip
C10	2.2 pF Chip Capacitor	Z10	0.070" x 0.080" Microstrip
C12	0.7 pF Chip Capacitor - MRF9045LS	Z11	0.240" x 0.080" Microstrip
C17	220 μ F, 50 V Electrolytic Capacitor	Z12	0.140" x 0.080" Microstrip
L1, L2	12.5 nH Surface Mount Inductors, Coilcraft	Z13	0.930" x 0.080" Microstrip
Z1	0.260" x 0.080" Microstrip	Z14	0.180" x 0.080" Microstrip
Z2	0.610" x 0.120" Microstrip	Z15	0.350" x 0.080" Microstrip
Z3	0.260" x 0.320" Microstrip	PCB	Arlon GX-0300-55-22, 0.03", $\epsilon_r = 2.55$

Figure 1. 930 - 960 MHz Broadband Test Circuit Schematic

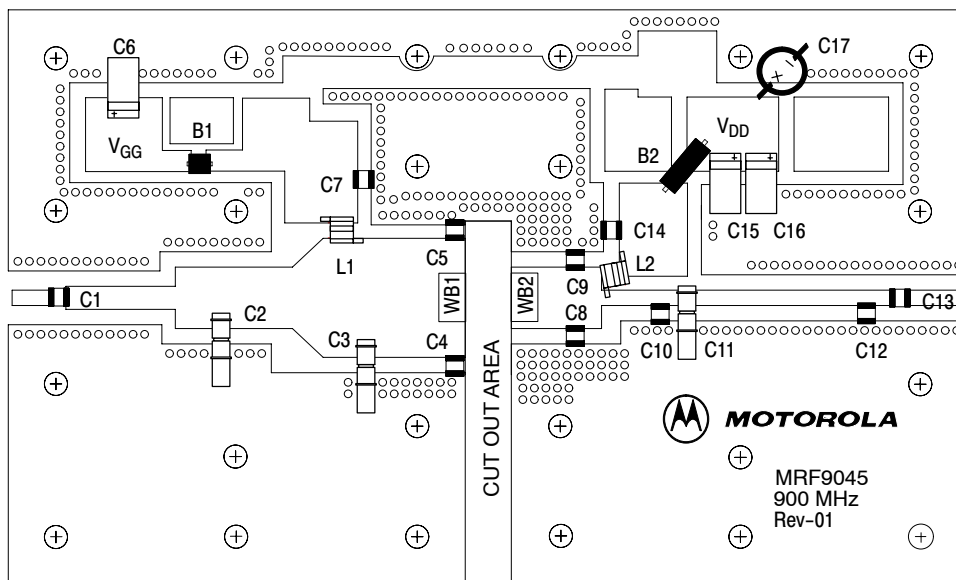

Freescle has begun the transition of marking Printed Circuit Boards (PCBs) with the Freescle Semiconductor signature/logo. PCBs may have either Motorola or Freescle markings during the transition period. These changes will have no impact on form, fit or function of the current product.

Figure 2. 930 - 960 MHz Broadband Test Circuit Component Layout

TYPICAL CHARACTERISTICS

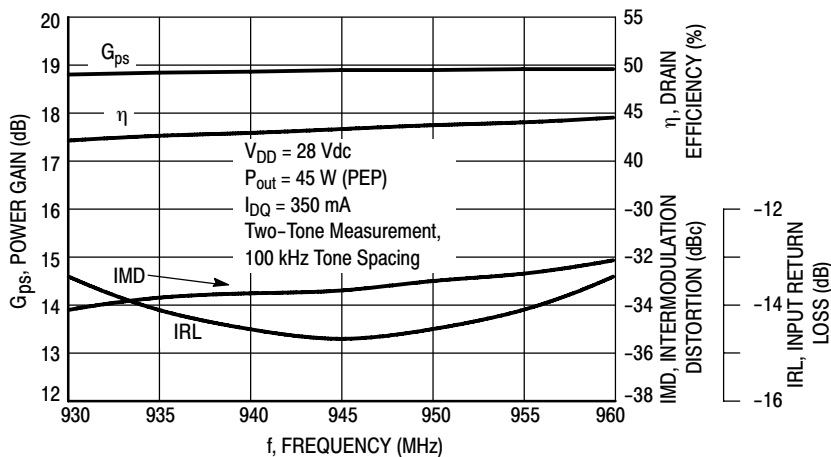

Figure 3. Class AB Broadband Circuit Performance

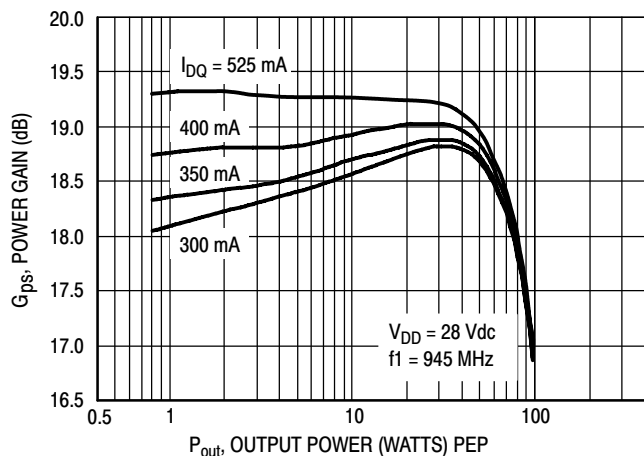

Figure 4. Power Gain versus Output Power

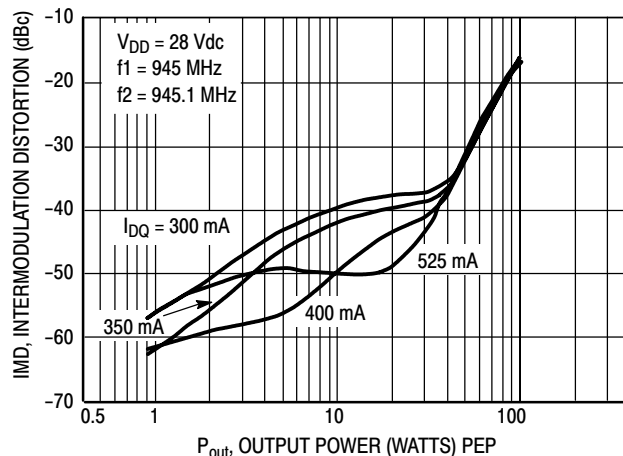

Figure 5. Intermodulation Distortion versus Output Power

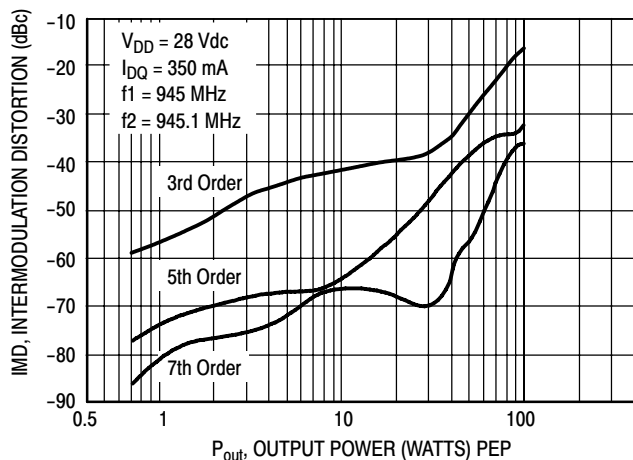

Figure 6. Intermodulation Distortion Products versus Output Power

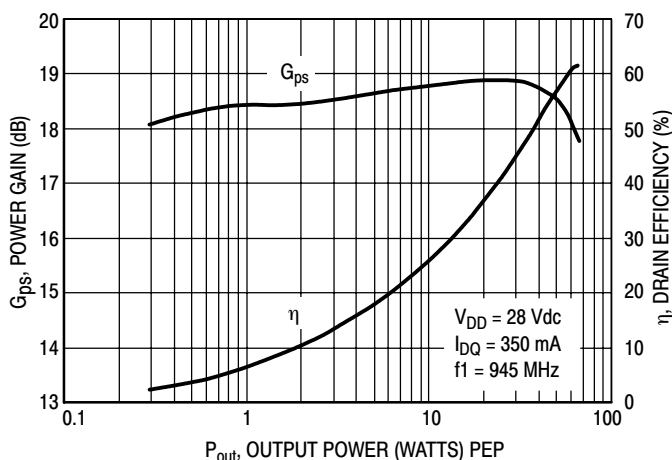
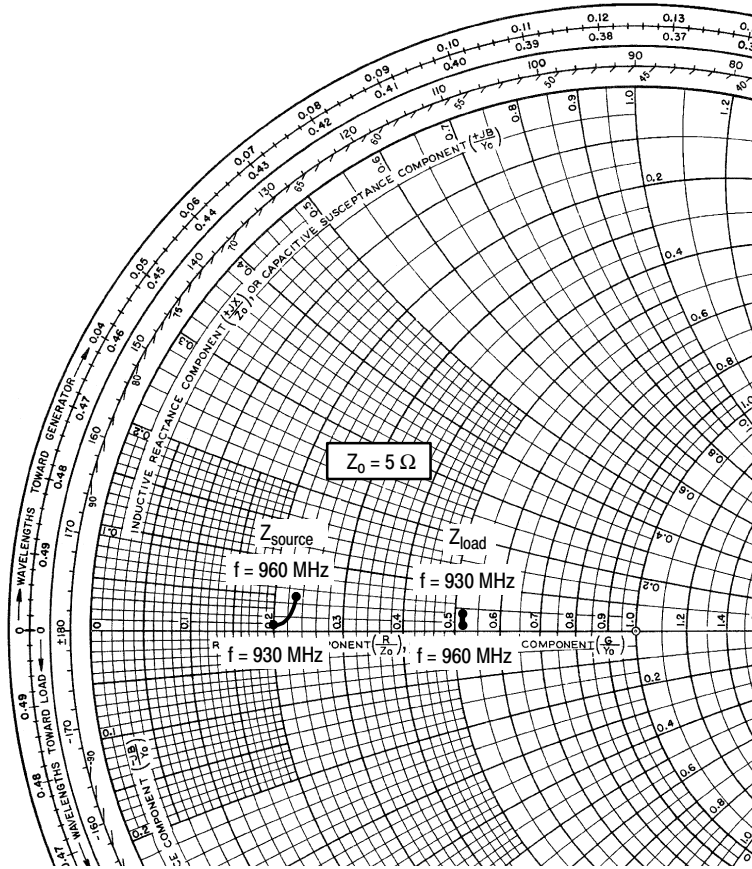

Figure 7. Power Gain, Efficiency versus Output Power

MRF9045LR1 MRF9045LSR1



$V_{DD} = 28\text{ V}$, $I_{DQ} = 350\text{ mA}$, $P_{out} = 45\text{ W PEP}$

f MHz	Z_{source} Ω	Z_{load} Ω
930	$1.02 + j0.06$	$2.6 + j0.20$
945	$1.10 + j0.11$	$2.6 + j0.16$
960	$1.15 + j0.25$	$2.6 + j0.10$

Z_{source} = Test circuit impedance as measured from gate to ground.

Z_{load} = Test circuit impedance as measured from drain to ground.

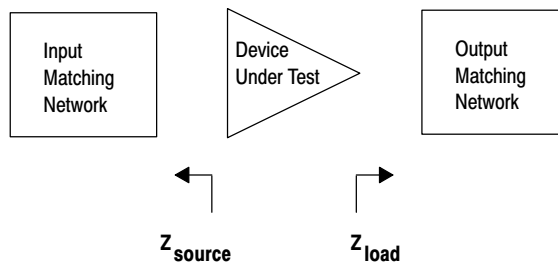
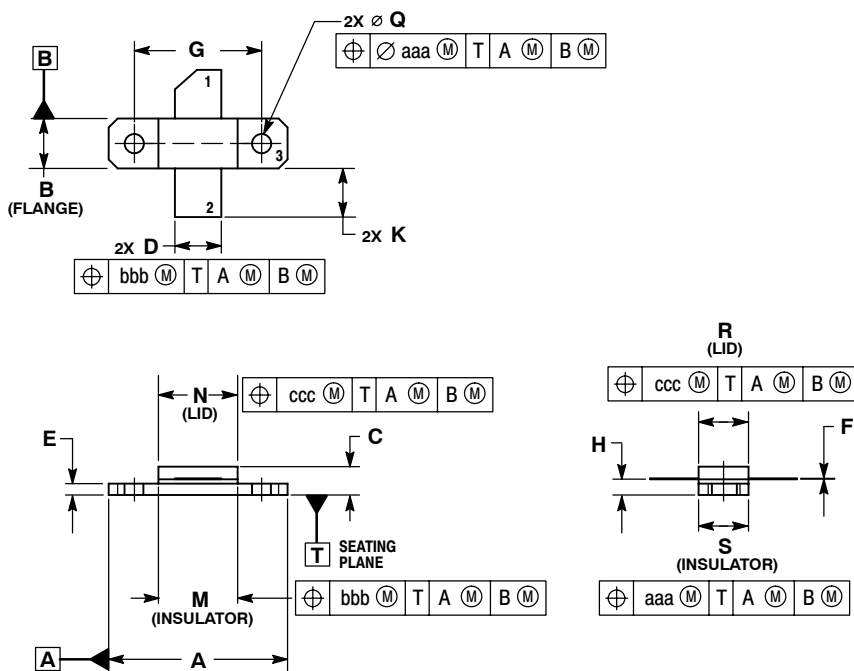

Figure 8. Series Equivalent Source and Load Impedance

PACKAGE DIMENSIONS



- NOTES:
1. INTERPRET DIMENSIONS AND TOLERANCES PER ASME Y14.5M-1994.
 2. CONTROLLING DIMENSION: INCH.
 3. DIMENSION H IS MEASURED 0.030 (0.762) AWAY FROM PACKAGE BODY.

DIM	INCHES		MILLIMETERS	
	MIN	MAX	MIN	MAX
A	0.795	0.805	20.19	20.45
B	0.225	0.235	5.72	5.97
C	0.125	0.175	3.18	4.45
D	0.210	0.220	5.33	5.59
E	0.055	0.065	1.40	1.65
F	0.004	0.006	0.10	0.15
G	0.562 BSC		14.28 BSC	
H	0.077	0.087	1.96	2.21
K	0.220	0.250	5.59	6.35
M	0.355	0.365	9.02	9.27
N	0.357	0.363	9.07	9.22
Q	0.125	0.135	3.18	3.43
R	0.227	0.233	5.77	5.92
S	0.225	0.235	5.72	5.97
aaa	0.005 REF		0.13 REF	
bbb	0.010 REF		0.25 REF	
ccc	0.015 REF		0.38 REF	

- STYLE 1:
 PIN 1. DRAIN
 2. GATE
 3. SOURCE

CASE 360B-05 ISSUE G NI-360 MRF9045LR1

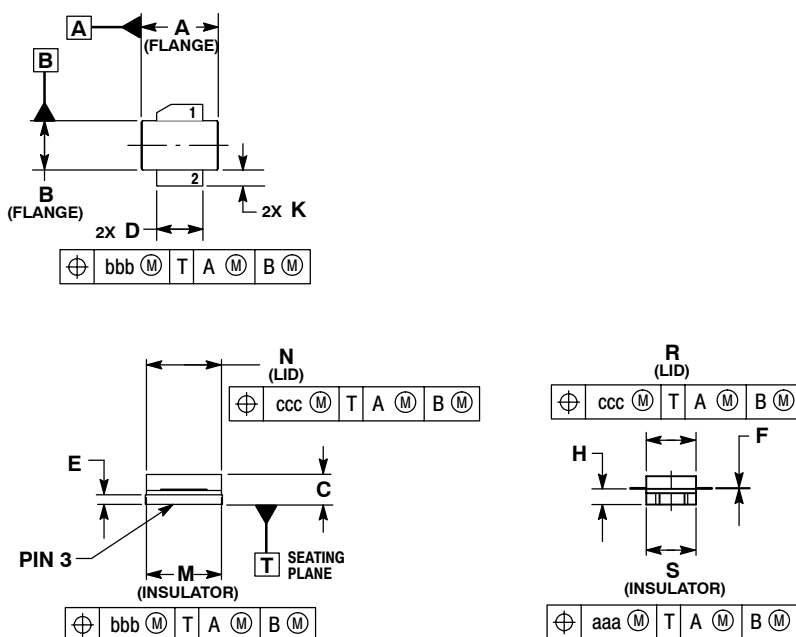

- NOTES:
1. INTERPRET DIMENSIONS AND TOLERANCES PER ASME Y14.5M-1994.
 2. CONTROLLING DIMENSION: INCH.
 3. DIMENSION H IS MEASURED 0.030 (0.762) AWAY FROM PACKAGE BODY.

DIM	INCHES		MILLIMETERS	
	MIN	MAX	MIN	MAX
A	0.375	0.385	9.53	9.78
B	0.225	0.235	5.72	5.97
C	0.105	0.155	2.67	3.94
D	0.210	0.220	5.33	5.59
E	0.035	0.045	0.89	1.14
F	0.004	0.006	0.10	0.15
H	0.057	0.067	1.45	1.70
K	0.085	0.115	2.16	2.92
M	0.355	0.365	9.02	9.27
N	0.357	0.363	9.07	9.22
R	0.227	0.23	5.77	5.92
S	0.225	0.235	5.72	5.97
aaa	0.005 REF		0.13 REF	
bbb	0.010 REF		0.25 REF	
ccc	0.015 REF		0.38 REF	

- STYLE 1:
 PIN 1. DRAIN
 2. GATE
 3. SOURCE

CASE 360C-05 ISSUE E NI-360S MRF9045LSR1

MRF9045LR1 MRF9045LSR1

How to Reach Us:

Home Page:

www.freescale.com

E-mail:

support@freescale.com

USA/Europe or Locations Not Listed:

Freescale Semiconductor
Technical Information Center, CH370
1300 N. Alma School Road
Chandler, Arizona 85224
+1-800-521-6274 or +1-480-768-2130
support@freescale.com

Europe, Middle East, and Africa:

Freescale Halbleiter Deutschland GmbH
Technical Information Center
Schatzbogen 7
81829 Muenchen, Germany
+44 1296 380 456 (English)
+46 8 52200080 (English)
+49 89 92103 559 (German)
+33 1 69 35 48 48 (French)
support@freescale.com

Japan:

Freescale Semiconductor Japan Ltd.
Headquarters
ARCO Tower 15F
1-8-1, Shimo-Meguro, Meguro-ku,
Tokyo 153-0064
Japan
0120 191014 or +81 3 5437 9125
support.japan@freescale.com

Asia/Pacific:

Freescale Semiconductor Hong Kong Ltd.
Technical Information Center
2 Dai King Street
Tai Po Industrial Estate
Tai Po, N.T., Hong Kong
+800 2666 8080
support.asia@freescale.com

For Literature Requests Only:

Freescale Semiconductor Literature Distribution Center
P.O. Box 5405
Denver, Colorado 80217
1-800-441-2447 or 303-675-2140
Fax: 303-675-2150
LDCForFreescaleSemiconductor@hibbertgroup.com

Information in this document is provided solely to enable system and software implementers to use Freescale Semiconductor products. There are no express or implied copyright licenses granted hereunder to design or fabricate any integrated circuits or integrated circuits based on the information in this document.

Freescale Semiconductor reserves the right to make changes without further notice to any products herein. Freescale Semiconductor makes no warranty, representation or guarantee regarding the suitability of its products for any particular purpose, nor does Freescale Semiconductor assume any liability arising out of the application or use of any product or circuit, and specifically disclaims any and all liability, including without limitation consequential or incidental damages. "Typical" parameters that may be provided in Freescale Semiconductor data sheets and/or specifications can and do vary in different applications and actual performance may vary over time. All operating parameters, including "Typicals", must be validated for each customer application by customer's technical experts. Freescale Semiconductor does not convey any license under its patent rights nor the rights of others. Freescale Semiconductor products are not designed, intended, or authorized for use as components in systems intended for surgical implant into the body, or other applications intended to support or sustain life, or for any other application in which the failure of the Freescale Semiconductor product could create a situation where personal injury or death may occur. Should Buyer purchase or use Freescale Semiconductor products for any such unintended or unauthorized application, Buyer shall indemnify and hold Freescale Semiconductor and its officers, employees, subsidiaries, affiliates, and distributors harmless against all claims, costs, damages, and expenses, and reasonable attorney fees arising out of, directly or indirectly, any claim of personal injury or death associated with such unintended or unauthorized use, even if such claim alleges that Freescale Semiconductor was negligent regarding the design or manufacture of the part.

Freescale™ and the Freescale logo are trademarks of Freescale Semiconductor, Inc. All other product or service names are the property of their respective owners.
© Freescale Semiconductor, Inc. 2006. All rights reserved.

