

## 2, 4-CHANNEL PROTECTION SOLUTION FOR SUPER-SPEED (6 GBPS) USB 3.0 INTERFACE

Check for Samples: [TPD2EUSB30](#), [TPD2EUSB30A](#), [TPD4EUSB30](#)

### FEATURES

- **Single and Dual-Pair Differential Lines to Protect the Differential Data and Clock Lines of the USB3.0, eSATA, or LVD Interface**
- **Flow-Through Pin Mapping for the High-Speed Lines Ensures near Zero Additional Skew Due to Board Layout While Placing Protection Chip Near the Connector**
- **Supports Data Rates in Excess of 6 Gbps**
- **ESD Protection Meets or Exceeds IEC61000-4-2 (Level 4)**
- **Low Capacitance 0.05pF (IO to IO)**
- **1  $\Omega$  Dynamic Resistance**
- **5-A Peak Pulse Current (per 8/20  $\mu$ s Pulse)**
- **Industrial Temperature Range:  $-40^{\circ}\text{C}$  to  $85^{\circ}\text{C}$**
- **Space-Saving DRT, DQA Packages**

### APPLICATIONS

- **Notebooks**
- **Set-Top Boxes**
- **DVD Players**
- **Media Players**
- **Portable Computers**

### DESCRIPTION/ORDERING INFORMATION

The TPD2EUSB30, TPD2EUSB30A, and TPD4EUSB30 provide 2 and 4 channel ESD and surge protection solutions in space saving, flow-through packages. These devices have been designed to protect sensitive components which are connected to ultra high-speed data and transmission lines. These devices also offer 5 A (8/20  $\mu$ s) peak pulse current ratings per IEC 61000-4-5 (lightning) specification.

The monolithic silicon technology allows matching between the differential signal pairs. The differential 0.05-pF capacitance ensures that the signal distortion due to added ESD clamp remains minimal at high-speed differential data transmission.

The TPD2EUSB30A offers low 4.5V dc break-down voltage. The low capacitance and break-down voltage, coupled low dynamic resistance, make the TPD2EUSB30A a superior ESD/ surge protection device for high-speed differential IOs based off ultra-low voltage process nodes.

The TPD2EUSB30 and TPD2EUSB30A are offered in space saving DRT (1 mm  $\times$  1 mm) package. The TPD4EUSB30 is offered in space saving DQA (1 mm  $\times$  2.5 mm) package. These devices are characterized for operation over ambient air temperature range of  $-40^{\circ}\text{C}$  to  $85^{\circ}\text{C}$ .

**DRT PACKAGE  
(TOP VIEW)**

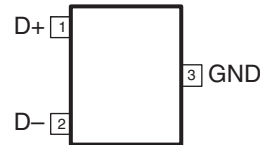

**DQA PACKAGE  
(TOP VIEW)**

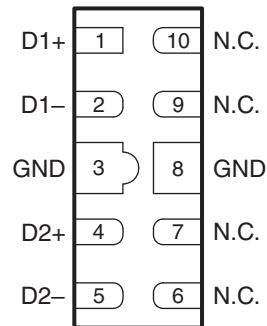

Please be aware that an important notice concerning availability, standard warranty, and use in critical applications of Texas Instruments semiconductor products and disclaimers thereto appears at the end of this data sheet.

**ORDERING INFORMATION**

T <sub>A</sub>	PACKAGE <sup>(1)</sup> <sup>(2)</sup>		ORDERABLE PART NUMBER	TOP-SIDE MARKING
-40°C to 85°C	SOT – DRT	Tape and reel	TPD2EUSB30DRTR	5PX
	SOT – DRT	Tape and reel	TPD2EUSB30ADRTR	5SX
	SON – DQA	Tape and reel	TPD4EUSB30DQAR	66R

- (1) Package drawings, thermal data, and symbolization are available at [www.ti.com/packaging](http://www.ti.com/packaging).
- (2) For the most current package and ordering information, see the Package Option Addendum at the end of this document, or see the TI website at [www.ti.com](http://www.ti.com).

**CIRCUIT DIAGRAMS**

**TPD4EUSB30 Circuit**

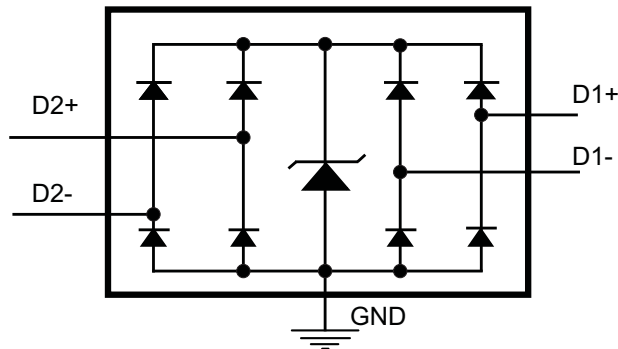

**TPD2EUSB30/A Circuit**

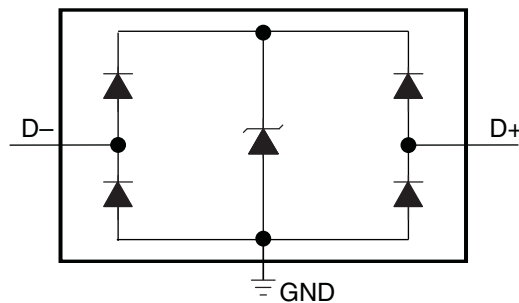

**TERMINAL FUNCTIONS**

TERMINAL			TYPE	DESCRIPTION
NAME	DRT PIN NO.	DQA PIN NO.		
Dx+, Dx-	1, 2	1,2, 4, 5	ESD port	High-speed ESD clamp, provides ESD protection to the high-speed differential data lines
GND	3	3, 8	GND	Ground
N.C.		6, 7, 9, 10		Not normally connected

**ABSOLUTE MAXIMUM RATINGS<sup>(1)</sup>**

over operating free-air temperature range (unless otherwise noted)

			MIN	MAX	UNIT
	IO voltage tolerance	D+, D– pins	0	6	
T <sub>A</sub>	Operating free-air temperature range		–40	85	°C
T <sub>stg</sub>	Storage temperature range		–65	125	°C
ESD protection	IEC 61000-4-2 Contact Discharge	D+, D– pins		±8	kV
	IEC 61000-4-2 Air-Gap Discharge (TPD2EUSB30/A)	D+, D– pins		±8	kV
	IEC 61000-4-2 Air-Gap Discharge (TPD4EUSB30)	D+, D– pins		±9	kV
	Peak pulse current (t <sub>p</sub> = 8/20 μs)	D+, D– pins		5	A
	Peak pulse power (t <sub>p</sub> = 8/20 μs)	D+, D– pins		45	W

(1) Stresses beyond those listed under "absolute maximum ratings" may cause permanent damage to the device. These are stress ratings only, and functional operation of the device at these or any other conditions beyond those indicated in the operational sections of the specifications is not implied. Exposure to absolute maximum-rated conditions for extended periods may affect device reliability.

**ELECTRICAL CHARACTERISTICS**

over operating free-air temperature range (unless otherwise noted)

PARAMETER		TEST CONDITIONS		MIN	TYP	MAX	UNIT
V <sub>RWM</sub>	Reverse stand-off voltage, TPD2EUSB30, TPD4EUSB30	D+,D– pins to ground				5.5	V
	Reverse stand-off voltage, TPD2EUSB30A	D+,D– pins to ground				3.6	V
V <sub>clamp</sub>	Clamp voltage	D+,D– pins to ground, I <sub>IO</sub> = 1 A				8	V
I <sub>IO</sub>	Current from IO port to supply pins	V <sub>IO</sub> = 2.5 V,	I <sub>D</sub> = 8 mA		0.01	0.1	μA
V <sub>D</sub>	Diode forward voltage	D+,D– pins, lower clamp diode,	V <sub>IO</sub> = 2.5 V, I <sub>D</sub> = 8 mA	0.6	0.8	0.95	V
R <sub>dyn</sub>	Dynamic resistance	D+,D– pins I = 1 A			1		Ω
C <sub>IO-IO</sub>	Capacitance IO to IO	D+,D– pins V <sub>IO</sub> = 2.5 V			0.05		pF
C <sub>IO-GND</sub>	Capacitance IO to GND	D+,D– pins (DRT)			0.7		pF
		D1+, D1-, D2+, D2- (DQA )		V <sub>IO</sub> = 2.5 V	0.8		
V <sub>BR</sub>	Break-down voltage, TPD2EUSB30, TPD4EUSB30	I <sub>IO</sub> = 1 mA		7			V
	Break-down voltage, TPD2EUSB30A	I <sub>IO</sub> = 1 mA		4.5			V

**TYPICAL OPERATING CHARACTERISTICS**

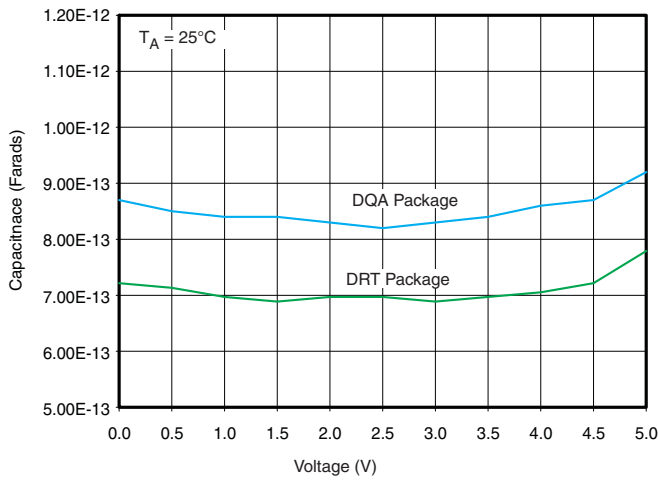

**Figure 1. IO Capacitance vs IO Voltage**

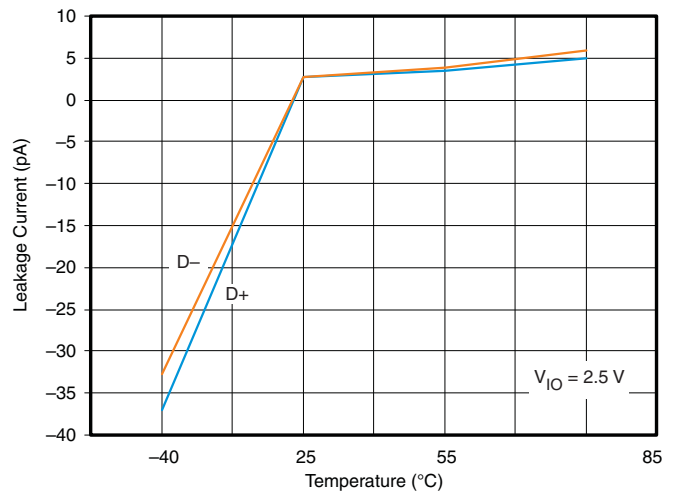

**Figure 2. Leakage Current vs Temperature**

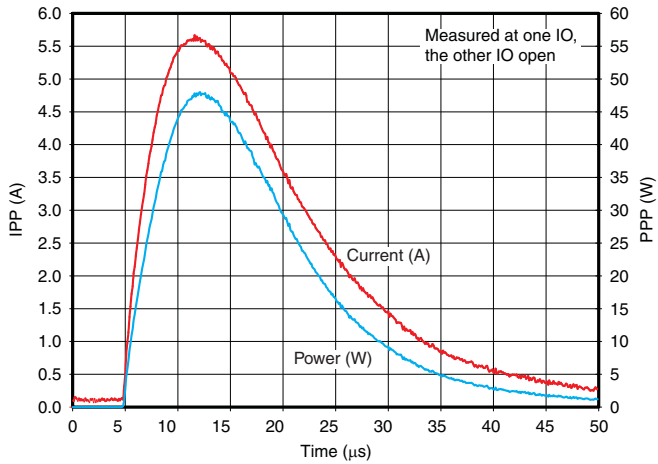

**Figure 3. Peak Pulse Waveforms**

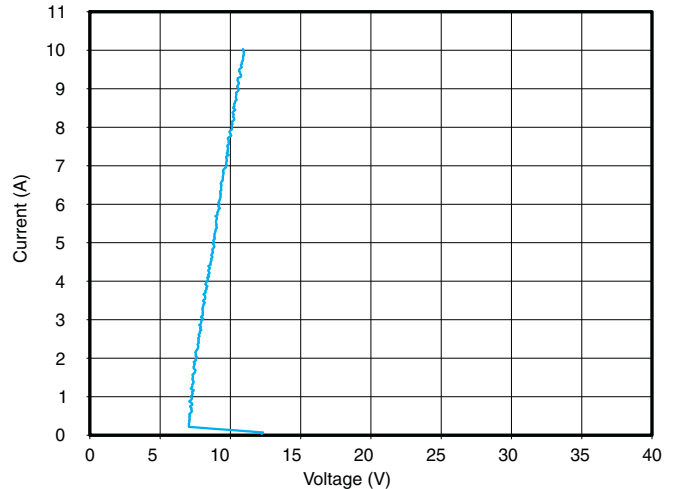

**Figure 4. D+, D- Transmission Line Pulsar Plot for TPD2EUSB30 (100 ns Pulse, 10 ns Rise Time)**

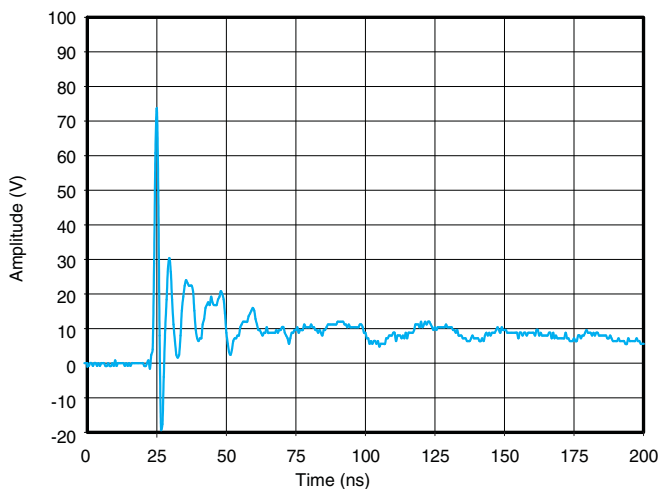

**Figure 5. IEC Clamping Waveforms (8 kV Contact)**

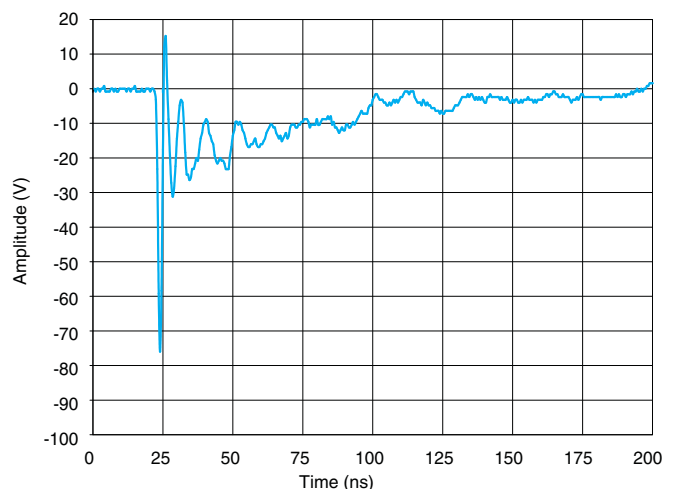

**Figure 6. IEC Clamping Waveforms (-8 kV Contact)**

## APPLICATION INFORMATION

### Layout Guide with TPDxEUSB30/A

Refer to [Figure 7](#), the TPD2EUSB30/A are offered in space saving DRT package. The DRT is a 1mm\* 1mm package with flow-through pin-mapping for the high-speed differential lines. The TPD4EUSB30 is offered in space saving DQA package. The DQA is a 1mm\* 2.5mm package with flow-through pin-mapping for the high-speed differential lines. It is recommended to place the package right next to the USB 3.0 connector. The GND pin should be connected to GND plane of the board through a large VIA. If a dedicated GND plane is not present right underneath, it is recommended to route to the GND plane through a wide trace. The current associated with IEC ESD stress can be in the range of 30Amps or higher momentarily. A good, low impedance GND path ensures the system robustness against IEC ESD stress.

The TPDxEUSB30/A can provide system level ESD protection to the high-speed differential ports (>6 Gbps data rate). The flow-through package offers flexibility for board routing with traces up to 15 mills wide. It allows the differential signal pairs couple together right after they touch the ESD ports of the TPDxEUSB30/A.

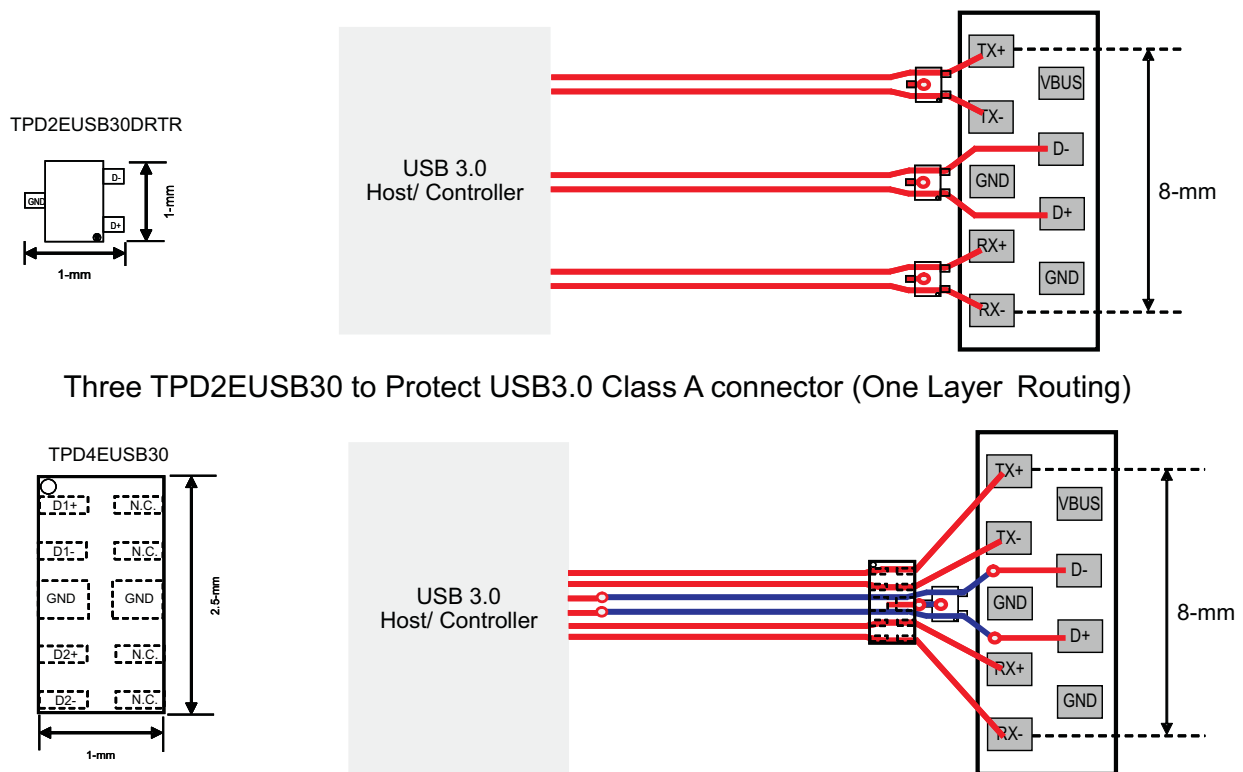

Three TPD2EUSB30 to Protect USB3.0 Class A connector (One Layer Routing)

One TPD4EUSB30 & One TPD2EUSB30 to Protect USB3.0 Class A connector (Two Layer Routing)

**Figure 7. Layout Guide with the TPDxEUSB30/A at the USB3.0 Class A Connector**

### TPDxEUSB30/A Eye Pattern Test

See [Figure 9](#) for a demonstration of the TPDxEUSB30/A performance in the lab set-up. [Figure 8](#) shows a lab board that was designed to demonstrate the degradation of the eye pattern quality with and without the TPD2EUSB30/A in the USB 3.0 signal path. [Figure 10](#) shows that there is only ~2 ps jitter penalty to the differential signal when the TPD2EUSB30/A device was added in the signal path. Similar setup was employed to measure eye pattern for the TPD4EUSB30.

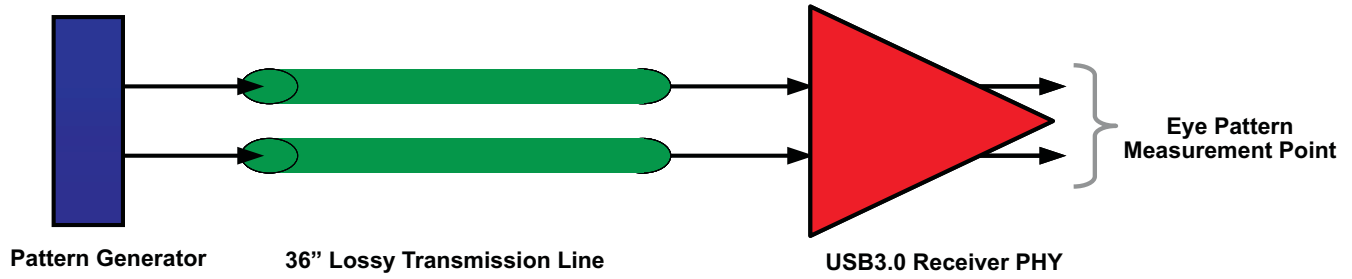

Figure 8. Measurement Setup to collect the Eye Pattern on a Reference Board with TPD2EUSB30/A

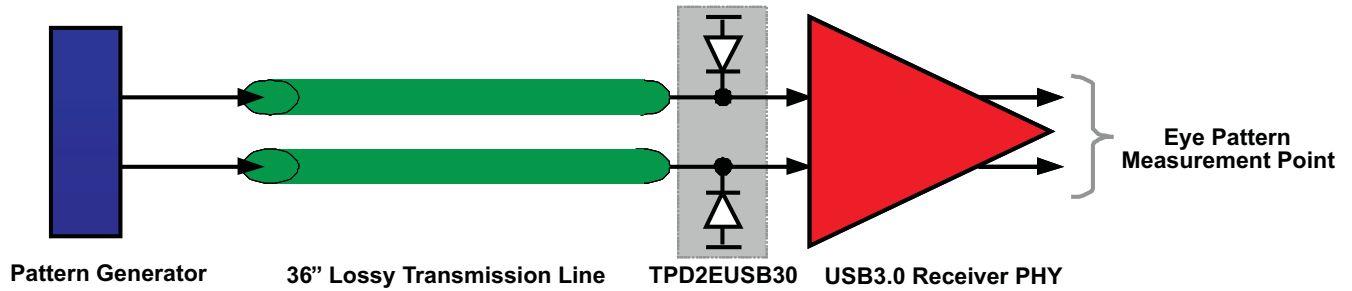

Figure 9. Measurement Setup to collect the Eye Pattern on a Reference Board with TPD2EUSB30/A

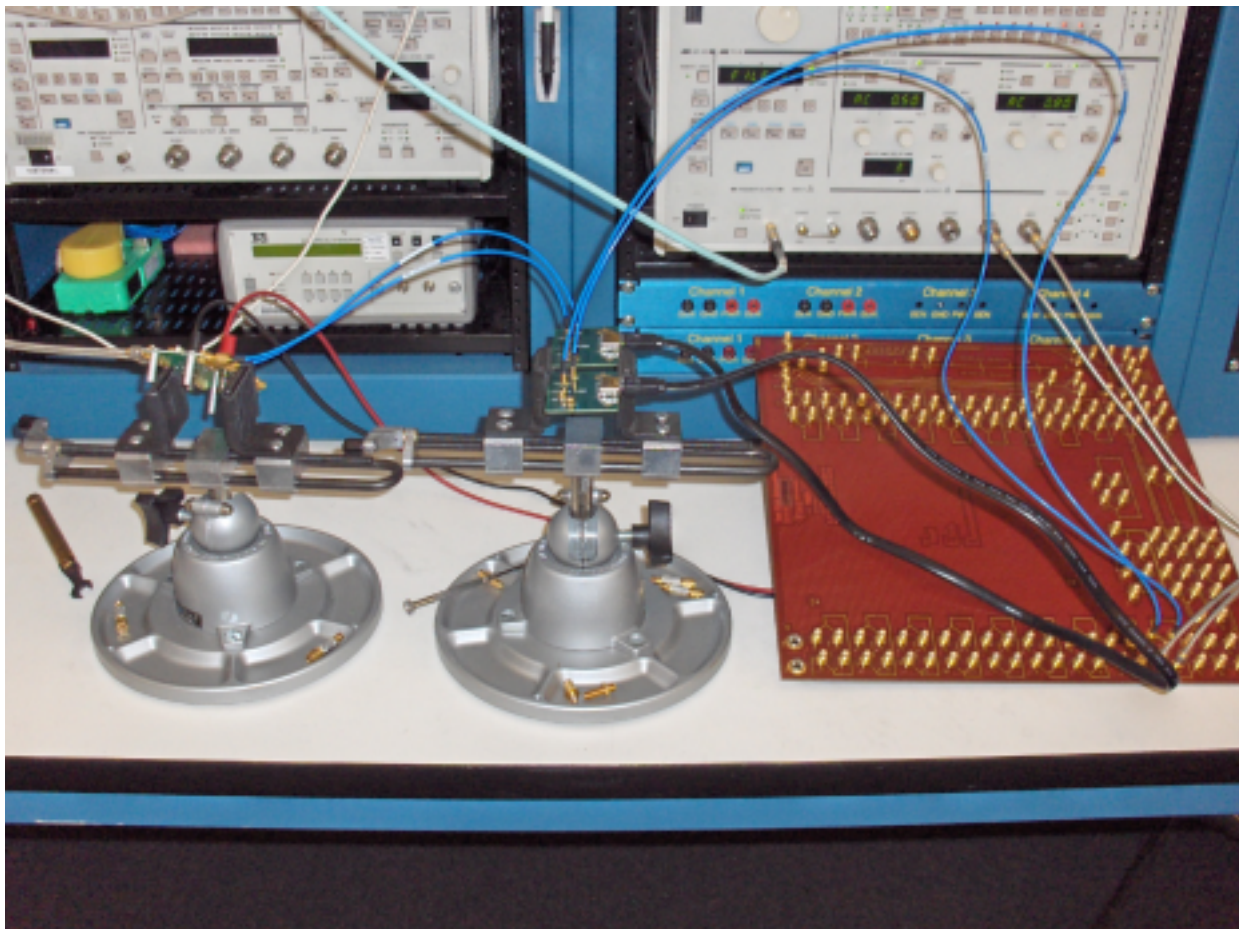

Figure 10. Lab Setup for the Eye-Pattern Measurement with TPDxUSB30/A



## REVISION HISTORY

Changes from Original (August 2010) to Revision A	Page
• Added TPS2EUSB30A part to document. ....	1

**PACKAGING INFORMATION**

Orderable Device	Status <sup>(1)</sup>	Package Type	Package Drawing	Pins	Package Qty	Eco Plan <sup>(2)</sup>	Lead/ Ball Finish	MSL Peak Temp <sup>(3)</sup>	Samples (Requires Login)
TPD2EUSB30ADRTR	ACTIVE	SOT	DRT	3	3000	Green (RoHS & no Sb/Br)	CU NIPDAU	Level-1-260C-UNLIM	<a href="#">Request Free Samples</a>
TPD2EUSB30DRTR	ACTIVE	SOT	DRT	3	3000	Green (RoHS & no Sb/Br)	CU NIPDAU	Level-1-260C-UNLIM	<a href="#">Request Free Samples</a>
TPD4EUSB30DQAR	ACTIVE	SON	DQA	10	3000	Green (RoHS & no Sb/Br)	CU NIPDAU	Level-1-260C-UNLIM	<a href="#">Request Free Samples</a>

<sup>(1)</sup> The marketing status values are defined as follows:

**ACTIVE:** Product device recommended for new designs.

**LIFEBUY:** TI has announced that the device will be discontinued, and a lifetime-buy period is in effect.

**NRND:** Not recommended for new designs. Device is in production to support existing customers, but TI does not recommend using this part in a new design.

**PREVIEW:** Device has been announced but is not in production. Samples may or may not be available.

**OBSOLETE:** TI has discontinued the production of the device.

<sup>(2)</sup> Eco Plan - The planned eco-friendly classification: Pb-Free (RoHS), Pb-Free (RoHS Exempt), or Green (RoHS & no Sb/Br) - please check <http://www.ti.com/productcontent> for the latest availability information and additional product content details.

**TBD:** The Pb-Free/Green conversion plan has not been defined.

**Pb-Free (RoHS):** TI's terms "Lead-Free" or "Pb-Free" mean semiconductor products that are compatible with the current RoHS requirements for all 6 substances, including the requirement that lead not exceed 0.1% by weight in homogeneous materials. Where designed to be soldered at high temperatures, TI Pb-Free products are suitable for use in specified lead-free processes.

**Pb-Free (RoHS Exempt):** This component has a RoHS exemption for either 1) lead-based flip-chip solder bumps used between the die and package, or 2) lead-based die adhesive used between the die and leadframe. The component is otherwise considered Pb-Free (RoHS compatible) as defined above.

**Green (RoHS & no Sb/Br):** TI defines "Green" to mean Pb-Free (RoHS compatible), and free of Bromine (Br) and Antimony (Sb) based flame retardants (Br or Sb do not exceed 0.1% by weight in homogeneous material)

<sup>(3)</sup> MSL, Peak Temp. -- The Moisture Sensitivity Level rating according to the JEDEC industry standard classifications, and peak solder temperature.

**Important Information and Disclaimer:** The information provided on this page represents TI's knowledge and belief as of the date that it is provided. TI bases its knowledge and belief on information provided by third parties, and makes no representation or warranty as to the accuracy of such information. Efforts are underway to better integrate information from third parties. TI has taken and continues to take reasonable steps to provide representative and accurate information but may not have conducted destructive testing or chemical analysis on incoming materials and chemicals. TI and TI suppliers consider certain information to be proprietary, and thus CAS numbers and other limited information may not be available for release.

In no event shall TI's liability arising out of such information exceed the total purchase price of the TI part(s) at issue in this document sold by TI to Customer on an annual basis.

**TAPE AND REEL INFORMATION**

**QUADRANT ASSIGNMENTS FOR PIN 1 ORIENTATION IN TAPE**



\*All dimensions are nominal

Device	Package Type	Package Drawing	Pins	SPQ	Reel Diameter (mm)	Reel Width W1 (mm)	A0 (mm)	B0 (mm)	K0 (mm)	P1 (mm)	W (mm)	Pin1 Quadrant
TPD2EUSB30ADRTR	SOT	DRT	3	3000	180.0	8.4	1.16	1.16	0.63	4.0	8.0	Q3
TPD2EUSB30DRTR	SOT	DRT	3	3000	180.0	8.4	1.16	1.16	0.63	4.0	8.0	Q3
TPD4EUSB30DQAR	SON	DQA	10	3000	180.0	8.4	1.3	2.83	0.65	4.0	8.0	Q1

**TAPE AND REEL BOX DIMENSIONS**

\*All dimensions are nominal

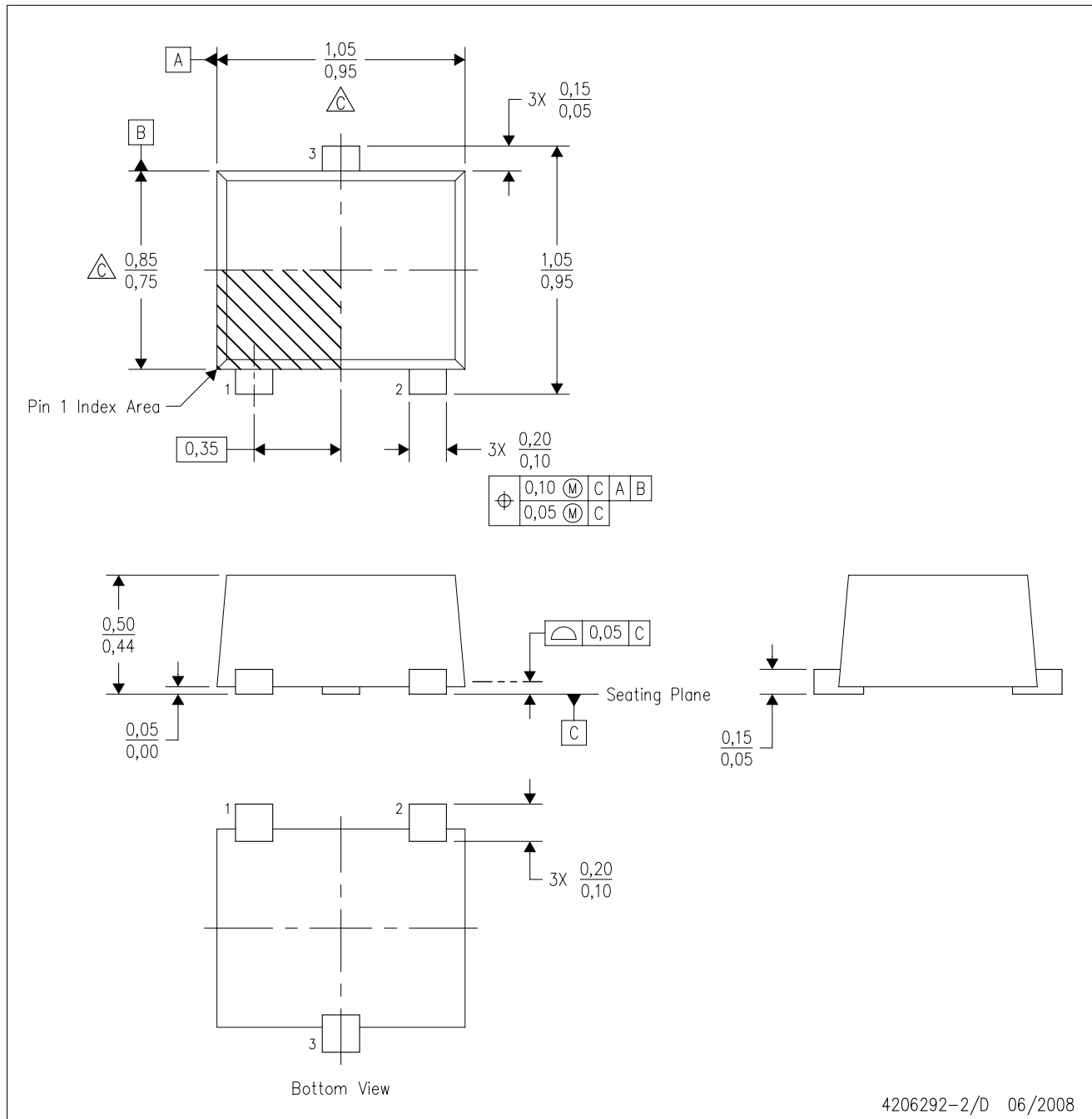
Device	Package Type	Package Drawing	Pins	SPQ	Length (mm)	Width (mm)	Height (mm)
TPD2EUSB30ADRTR	SOT	DRT	3	3000	202.0	201.0	28.0
TPD2EUSB30DRTR	SOT	DRT	3	3000	202.0	201.0	28.0
TPD4EUSB30DQAR	SON	DQA	10	3000	202.0	201.0	28.0



- NOTES:
- A. All linear dimensions are in millimeters. Dimensioning and tolerancing per ASME Y14.5M-1994.
  - B. This drawing is subject to change without notice.
  - C. Body dimensions do not include mold flash, interlead flash, protrusions, or gate burrs. Mold flash, interlead flash, protrusions, or gate burrs shall not exceed 0,10 per end or side.
  - D. JEDEC package registration is pending.

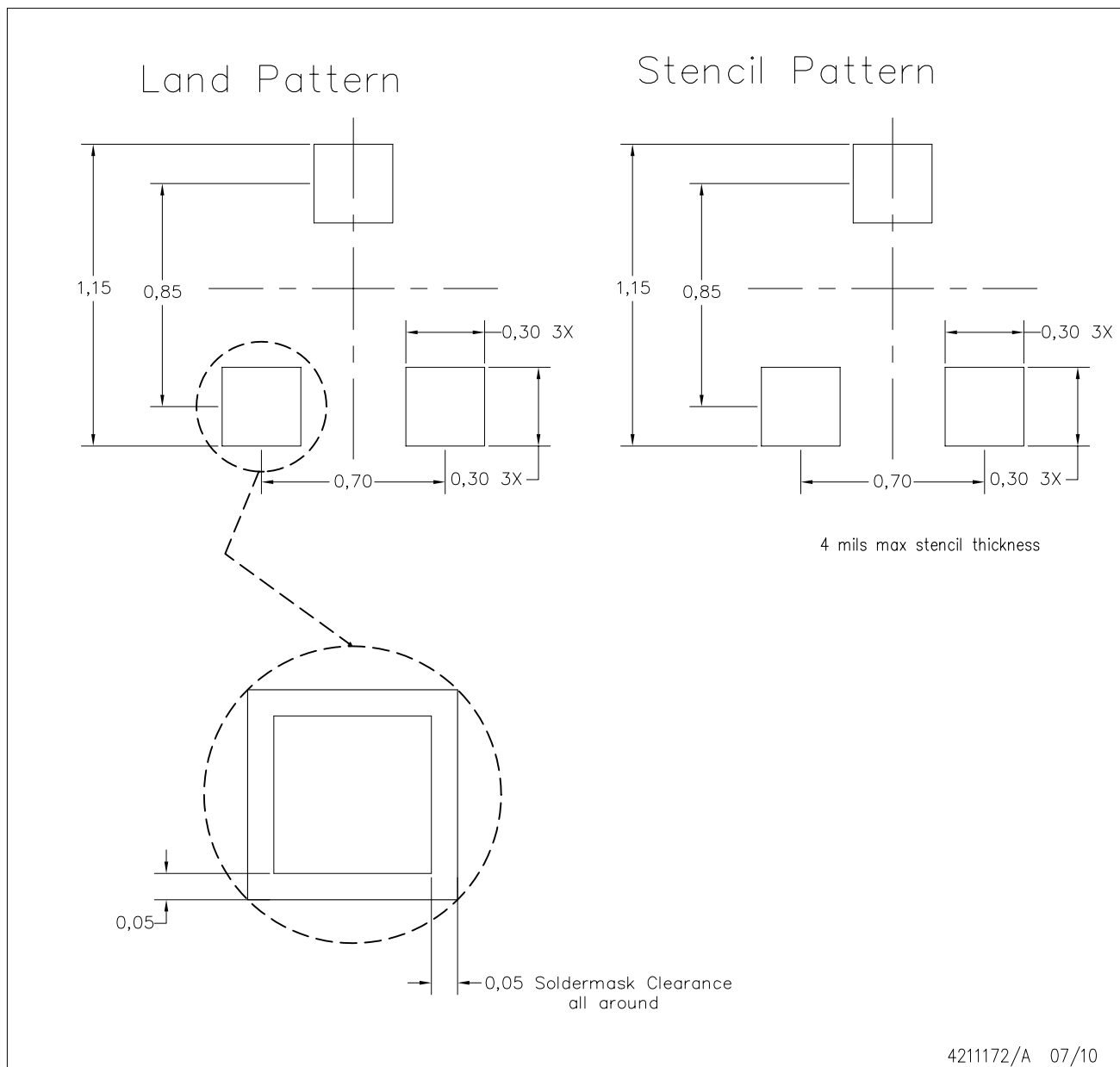

4211172/A 07/10

- NOTES:
- All linear dimensions are in millimeters.
  - This drawing is subject to change without notice.
  - Publication IPC-7351 is recommended for alternate designs.
  - Customers should contact their board fabrication site for minimum solder mask web tolerances between signal pads.
  - Maximum stencil thickness 0,1016 mm (4 mils). All linear dimensions are in millimeters.
  - Laser cutting apertures with trapezoidal walls and also rounding corners will offer better paste release. Customers should contact their board assembly site for stencil design recommendations. Refer to IPC 7525 for stencil design considerations.
  - Side aperture dimensions over-print land for acceptable area ratio > 0.66. Customer may reduce side aperture dimensions if stencil manufacturing process allows for sufficient release at smaller opening.

DQA (R-PSON-N10)

PLASTIC SMALL OUTLINE NO-LEAD

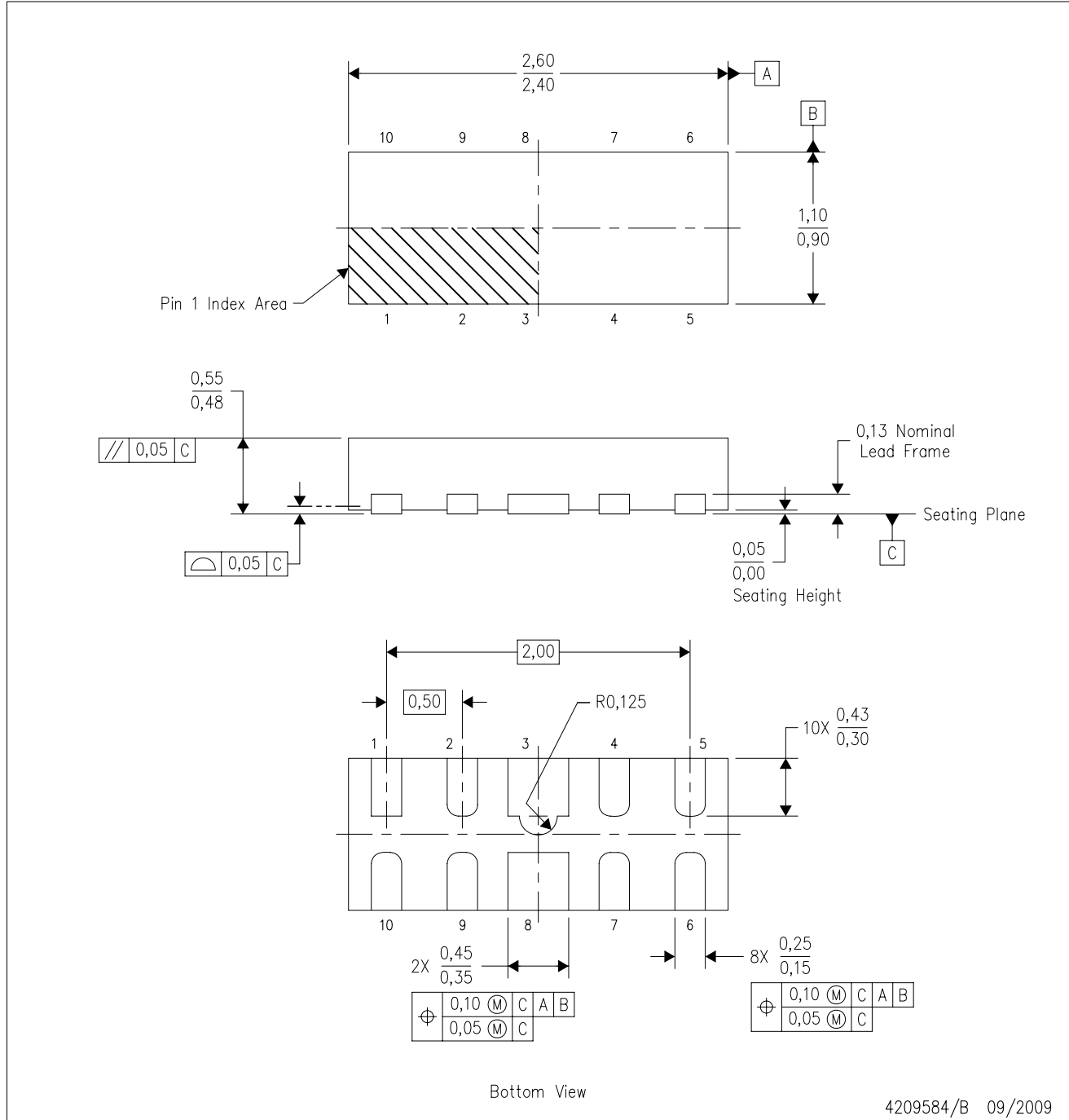

- NOTES:
- A. All linear dimensions are in millimeters. Dimensioning and tolerancing per ASME Y14.5M-1994.
  - B. This drawing is subject to change without notice.
  - C. SON (Small Outline No-Lead) package configuration.

DQA (R-PSON-N10)

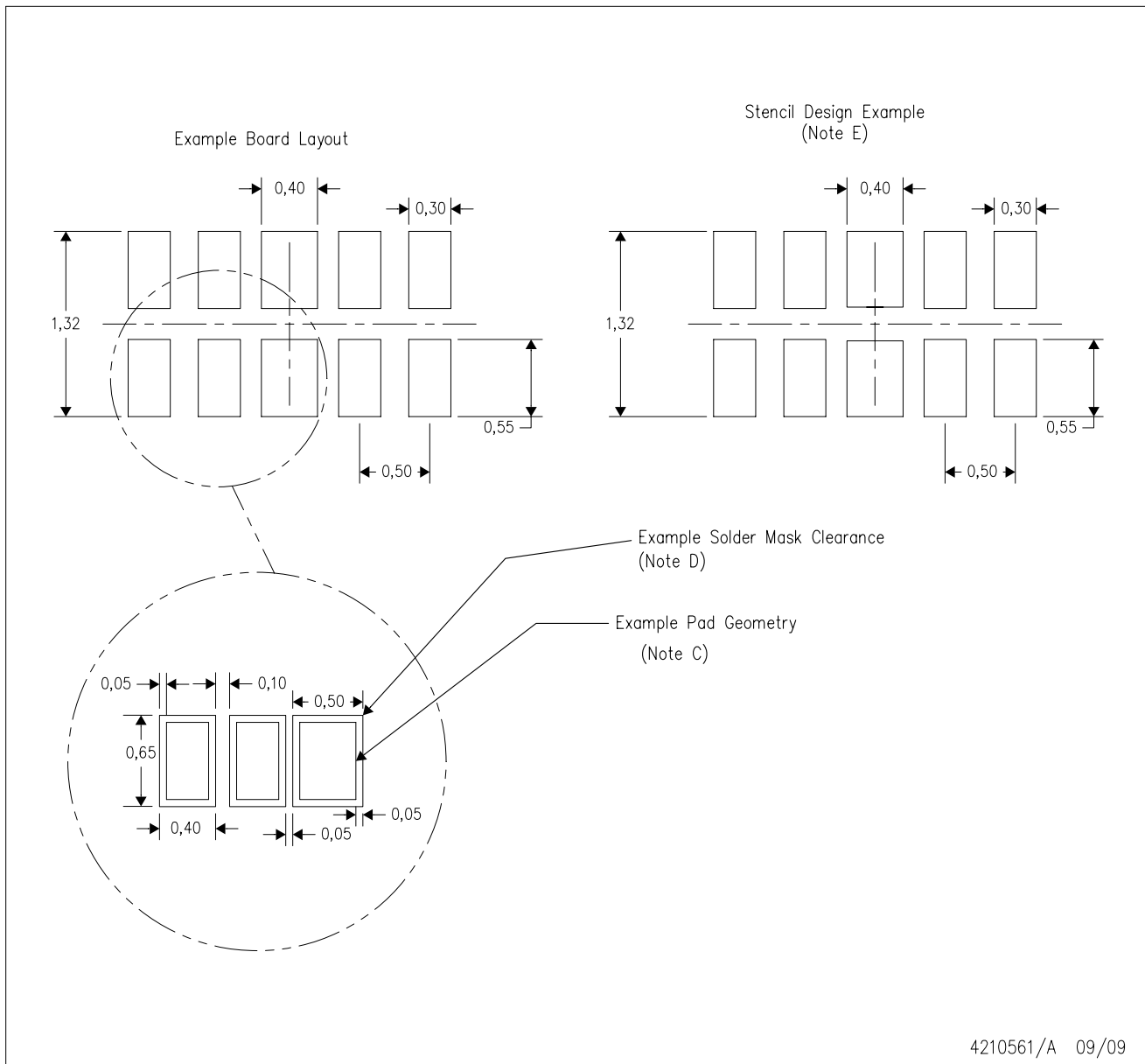

- NOTES:
- All linear dimensions are in millimeters.
  - This drawing is subject to change without notice.
  - Publication IPC-7351 is recommended for alternate designs.
  - Customers should contact their board fabrication site for minimum solder mask web tolerances between signal pads.
  - Maximum stencil thickness 0,127 mm (5 mils). All linear dimensions are in millimeters.
  - Laser cutting apertures with trapezoidal walls and also rounding corners will offer better paste release. Customers should contact their board assembly site for stencil design recommendations. Refer to IPC 7525 for stencil design considerations.
  - Side aperture dimensions over-print land for acceptable area ratio > 0.66. Customer may reduce side aperture dimensions if stencil manufacturing process allows for sufficient release at smaller opening.

## IMPORTANT NOTICE

Texas Instruments Incorporated and its subsidiaries (TI) reserve the right to make corrections, modifications, enhancements, improvements, and other changes to its products and services at any time and to discontinue any product or service without notice. Customers should obtain the latest relevant information before placing orders and should verify that such information is current and complete. All products are sold subject to TI's terms and conditions of sale supplied at the time of order acknowledgment.

TI warrants performance of its hardware products to the specifications applicable at the time of sale in accordance with TI's standard warranty. Testing and other quality control techniques are used to the extent TI deems necessary to support this warranty. Except where mandated by government requirements, testing of all parameters of each product is not necessarily performed.

TI assumes no liability for applications assistance or customer product design. Customers are responsible for their products and applications using TI components. To minimize the risks associated with customer products and applications, customers should provide adequate design and operating safeguards.

TI does not warrant or represent that any license, either express or implied, is granted under any TI patent right, copyright, mask work right, or other TI intellectual property right relating to any combination, machine, or process in which TI products or services are used. Information published by TI regarding third-party products or services does not constitute a license from TI to use such products or services or a warranty or endorsement thereof. Use of such information may require a license from a third party under the patents or other intellectual property of the third party, or a license from TI under the patents or other intellectual property of TI.

Reproduction of TI information in TI data books or data sheets is permissible only if reproduction is without alteration and is accompanied by all associated warranties, conditions, limitations, and notices. Reproduction of this information with alteration is an unfair and deceptive business practice. TI is not responsible or liable for such altered documentation. Information of third parties may be subject to additional restrictions.

Resale of TI products or services with statements different from or beyond the parameters stated by TI for that product or service voids all express and any implied warranties for the associated TI product or service and is an unfair and deceptive business practice. TI is not responsible or liable for any such statements.

TI products are not authorized for use in safety-critical applications (such as life support) where a failure of the TI product would reasonably be expected to cause severe personal injury or death, unless officers of the parties have executed an agreement specifically governing such use. Buyers represent that they have all necessary expertise in the safety and regulatory ramifications of their applications, and acknowledge and agree that they are solely responsible for all legal, regulatory and safety-related requirements concerning their products and any use of TI products in such safety-critical applications, notwithstanding any applications-related information or support that may be provided by TI. Further, Buyers must fully indemnify TI and its representatives against any damages arising out of the use of TI products in such safety-critical applications.

TI products are neither designed nor intended for use in military/aerospace applications or environments unless the TI products are specifically designated by TI as military-grade or "enhanced plastic." Only products designated by TI as military-grade meet military specifications. Buyers acknowledge and agree that any such use of TI products which TI has not designated as military-grade is solely at the Buyer's risk, and that they are solely responsible for compliance with all legal and regulatory requirements in connection with such use.

TI products are neither designed nor intended for use in automotive applications or environments unless the specific TI products are designated by TI as compliant with ISO/TS 16949 requirements. Buyers acknowledge and agree that, if they use any non-designated products in automotive applications, TI will not be responsible for any failure to meet such requirements.

Following are URLs where you can obtain information on other Texas Instruments products and application solutions:

### Products

Audio	<a href="http://www.ti.com/audio">www.ti.com/audio</a>
Amplifiers	<a href="http://amplifier.ti.com">amplifier.ti.com</a>
Data Converters	<a href="http://dataconverter.ti.com">dataconverter.ti.com</a>
DLP® Products	<a href="http://www.dlp.com">www.dlp.com</a>
DSP	<a href="http://dsp.ti.com">dsp.ti.com</a>
Clocks and Timers	<a href="http://www.ti.com/clocks">www.ti.com/clocks</a>
Interface	<a href="http://interface.ti.com">interface.ti.com</a>
Logic	<a href="http://logic.ti.com">logic.ti.com</a>
Power Mgmt	<a href="http://power.ti.com">power.ti.com</a>
Microcontrollers	<a href="http://microcontroller.ti.com">microcontroller.ti.com</a>
RFID	<a href="http://www.ti-rfid.com">www.ti-rfid.com</a>
RF/IF and ZigBee® Solutions	<a href="http://www.ti.com/lprf">www.ti.com/lprf</a>

### Applications

Communications and Telecom	<a href="http://www.ti.com/communications">www.ti.com/communications</a>
Computers and Peripherals	<a href="http://www.ti.com/computers">www.ti.com/computers</a>
Consumer Electronics	<a href="http://www.ti.com/consumer-apps">www.ti.com/consumer-apps</a>
Energy and Lighting	<a href="http://www.ti.com/energy">www.ti.com/energy</a>
Industrial	<a href="http://www.ti.com/industrial">www.ti.com/industrial</a>
Medical	<a href="http://www.ti.com/medical">www.ti.com/medical</a>
Security	<a href="http://www.ti.com/security">www.ti.com/security</a>
Space, Avionics and Defense	<a href="http://www.ti.com/space-avionics-defense">www.ti.com/space-avionics-defense</a>
Transportation and Automotive	<a href="http://www.ti.com/automotive">www.ti.com/automotive</a>
Video and Imaging	<a href="http://www.ti.com/video">www.ti.com/video</a>
Wireless	<a href="http://www.ti.com/wireless-apps">www.ti.com/wireless-apps</a>

TI E2E Community Home Page

[e2e.ti.com](http://e2e.ti.com)

Mailing Address: Texas Instruments, Post Office Box 655303, Dallas, Texas 75265  
Copyright © 2011, Texas Instruments Incorporated