

5 A - 60 V power Schottky rectifier

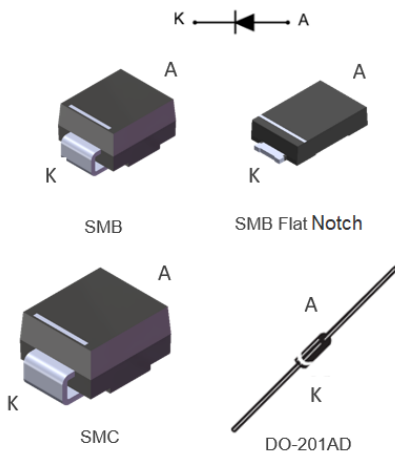

Features

- Negligible switching losses
- Low forward voltage drop
- Low thermal resistance
- Avalanche rated
- **ECOPACK2** component

Applications

- Lighting
- Battery charger
- Set-top box
- DC / DC converter
- Notebook adapter
- Switching diode

Description

Axial and surface mount power Schottky rectifier suited for switch mode power supplies and high frequency dc to dc converters.

Packaged in DO-201AD, SMB, SMC and SMB Flat Notch, this device is intended for use in low voltage, high frequency inverters and small battery chargers and for applications where there are space constraints, for example telecom battery charger.

Product status	
STPS5L60	
Product summary	
Symbol	Value
$I_{F(AV)}$	5 A
V_{RRM}	60 V
$T_{j(max.)}$	150 °C
$V_{F(typ.)}$	0.42 V

1 Characteristics

Table 1. Absolute ratings (limiting values at 25 °C, unless otherwise specified)

Symbol	Parameter		Value	Unit	
V_{RRM}	Repetitive peak reverse voltage		60	V	
$I_{F(RMS)}$	Forward rms current		15	A	
$I_{F(AV)}$	Average forward current, $\delta = 0.5$, square wave	SMB $T_L = 80\text{ °C}$	5	A	
		SMC, DO-201AD, SMB Flat Notch $T_L = 100\text{ °C}$			
I_{FSM}	Surge non repetitive forward current	SMC, DO-201AD, SMB	100	A	
		SMB Flat Notch $t_p = 10\text{ ms sinusoidal}$			205
P_{ARM}	Repetitive peak avalanche power		$t_p = 10\text{ }\mu\text{s}, T_j = 125\text{ °C}$	144	W
T_{stg}	Storage temperature range		-65 to +150	°C	
T_j	Maximum operating junction temperature ⁽¹⁾		+150	°C	

1. $(dP_{tot}/dT_j) < (1/R_{th(j-a)})$ condition to avoid thermal runaway for a diode on its own heatsink.

Table 2. Thermal resistance parameter

Symbol	Parameter		Max. value	Unit
$R_{th(j-l)}$	Junction to lead	DO-201AD lead length = 10 mm	15	°C/W
		SMB	20	
		SMC, SMB Flat Notch	15	
$R_{th(j-a)}$	Junction to ambient	DO-201AD	75	

For more information, please refer to the following application note :

- AN5088 : Rectifiers thermal management, handling and mounting recommendations

Table 3. Static electrical characteristics

Symbol	Parameter	Test conditions		Min.	Typ.	Max.	Unit
$I_R^{(1)}$	Reverse leakage current	$T_j = 25\text{ °C}$	$V_R = V_{RRM}$	-		0.22	mA
		$T_j = 100\text{ °C}$		-	10	25	
		$T_j = 110\text{ °C}$		-	25	55	
		$T_j = 125\text{ °C}$		-	40	100	
$V_F^{(1)}$	Forward voltage drop	$T_j = 25\text{ °C}$	$I_F = 5\text{ A}$	-	0.47	0.52	V
		$T_j = 100\text{ °C}$		-	0.43	0.49	
		$T_j = 125\text{ °C}$		-	0.42	0.48	

1. Pulse test: $t_p = 380\text{ }\mu\text{s}, \delta < 2\%$

To evaluate the conduction losses, use the following equation:

$$P = 0.39 \times I_{F(AV)} + 0.028 \times I_{F(RMS)}^2$$

For more information, please refer to the following application notes related to the power losses :

- AN604: Calculation of conduction losses in a power rectifier
- AN4021: Calculation of reverse losses on a power diode

1.1 Characteristics (curves)

Figure 1. Average forward power dissipation versus average forward current

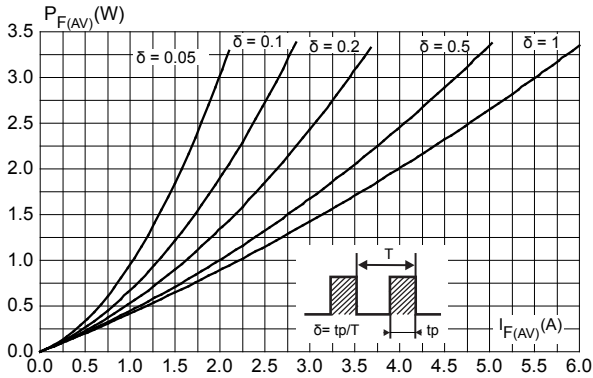

Figure 2. Average forward current versus ambient temperature ($\delta = 0.5$)

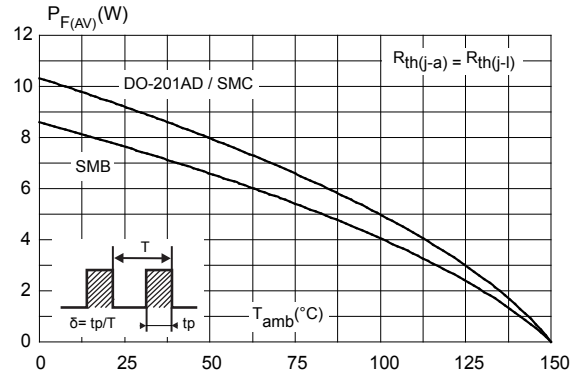

Figure 3. Normalized avalanche power derating versus pulse duration ($T_j = 125^\circ\text{C}$)

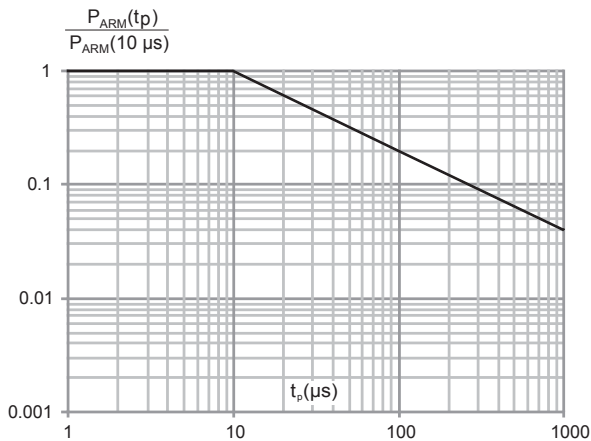

Figure 4. Relative variation of thermal impedance junction to lead versus pulse duration (SMB)

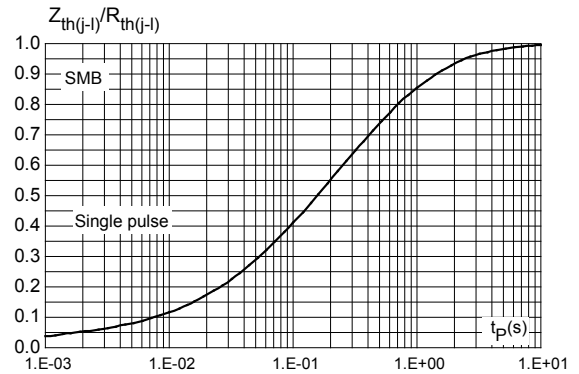

Figure 5. Relative variation of thermal impedance junction to ambient versus pulse duration (DO-201AD)

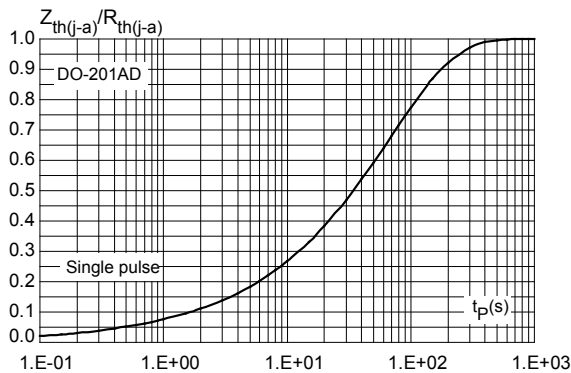

Figure 6. Relative variation of thermal impedance junction to ambient versus pulse duration (SMC)

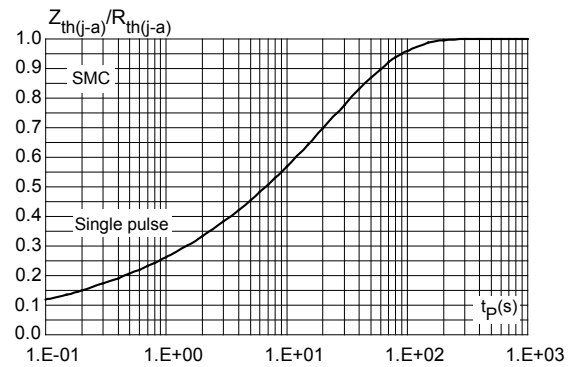

Figure 7. Reverse leakage current versus reverse voltage applied (typical values)

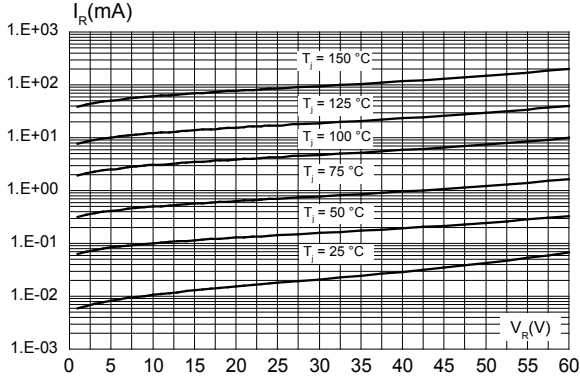

Figure 8. Junction capacitance versus reverse voltage applied (typical values)

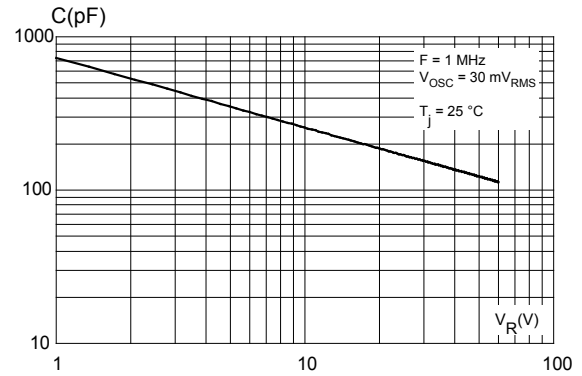

Figure 9. Forward voltage drop versus forward current (low level)

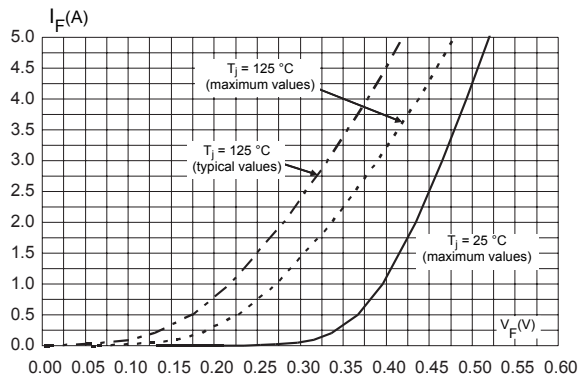

Figure 10. Forward voltage drop versus forward current (high level)

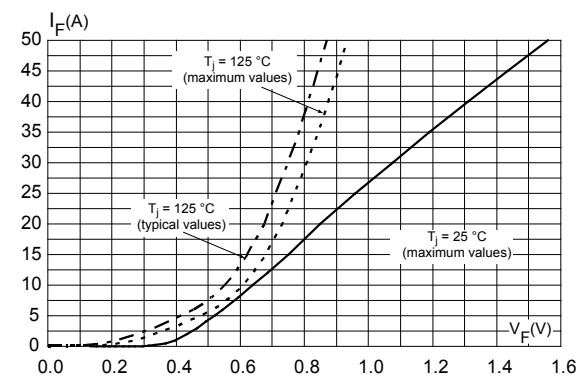

Figure 11. Thermal resistance junction to ambient versus copper surface under each lead (SMB)

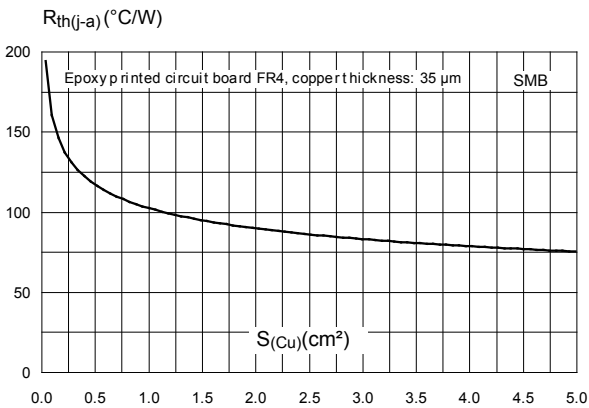

Figure 12. Thermal resistance junction to ambient versus copper surface under each lead (SMB flat Notch)

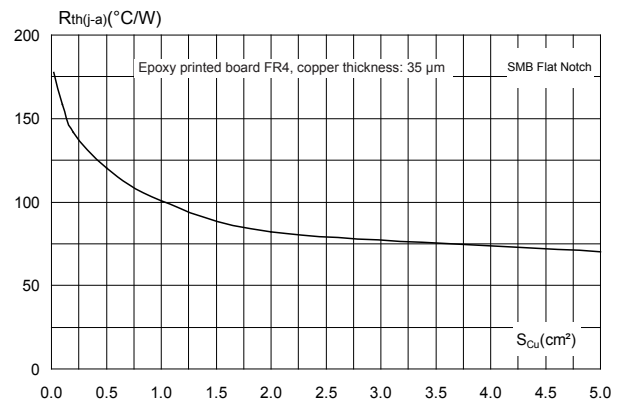

Figure 13. Thermal resistance junction to ambient versus copper surface under each lead (SMC)

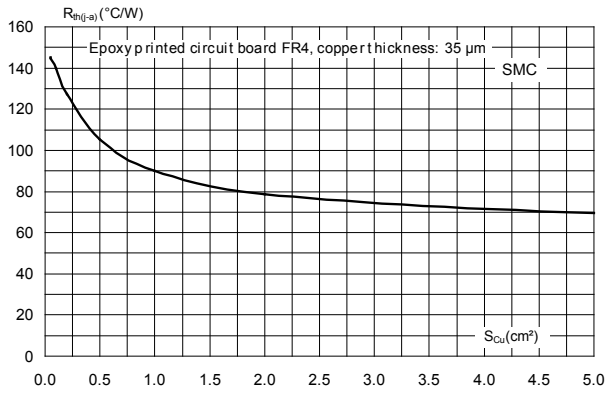
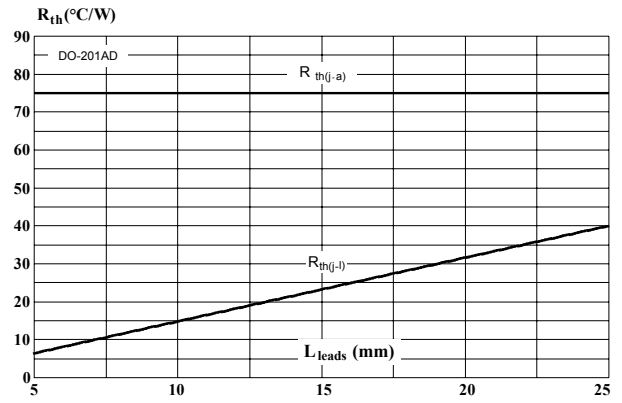

Figure 14. Thermal resistance versus lead length



2 Package information

In order to meet environmental requirements, ST offers these devices in different grades of **ECOPACK** packages, depending on their level of environmental compliance. ECOPACK specifications, grade definitions and product status are available at: www.st.com. ECOPACK is an ST trademark.

2.1 SMB Flat Notch package information

- Epoxy meets UL94, V0
- Lead-free package

Figure 15. SMB Flat Notch package outline

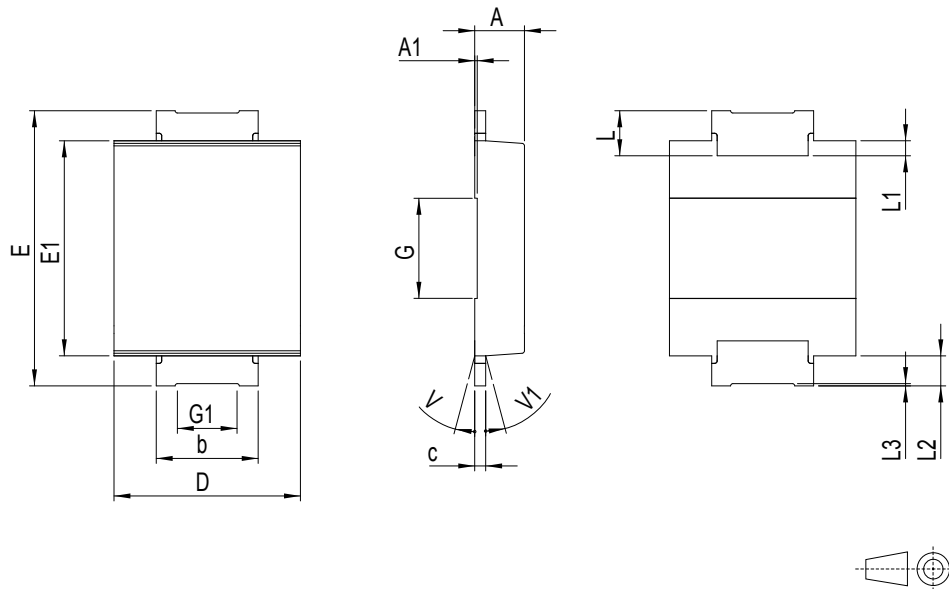
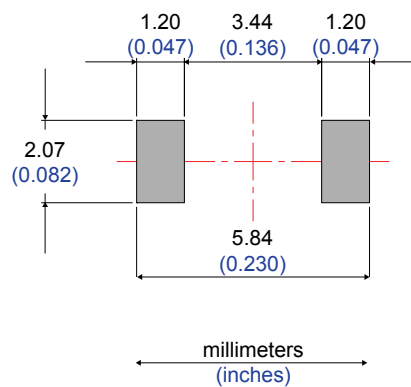

Table 4. SMB Flat Notch mechanical data

Ref.	Dimensions					
	Millimeters			Inches		
	Min.	Typ.	Max.	Min.	Typ.	Max.
A	0.90		1.10	0.035		0.043
A1		0.05			0.002	
b	1.95		2.20	0.077		0.087
c	0.15		0.40	0.006		0.016
D	3.30		3.95	0.130		0.156
E	5.20		5.60	0.205		0.220
E1	4.05		4.60	0.159		0.181
G		2.00			0.079	
G1		1.20			0.047	
L	0.75		1.20	0.030		0.047
L1		0.30			0.012	
L2		0.60			0.024	
L3	0.02			0.001		
V			8°			8°
V1			8°			8°

Figure 16. Footprint recommendations, dimensions in mm (inches)



2.2 SMB package information

- Epoxy meets UL94, V0
- Lead-free package

Figure 17. SMB package outline

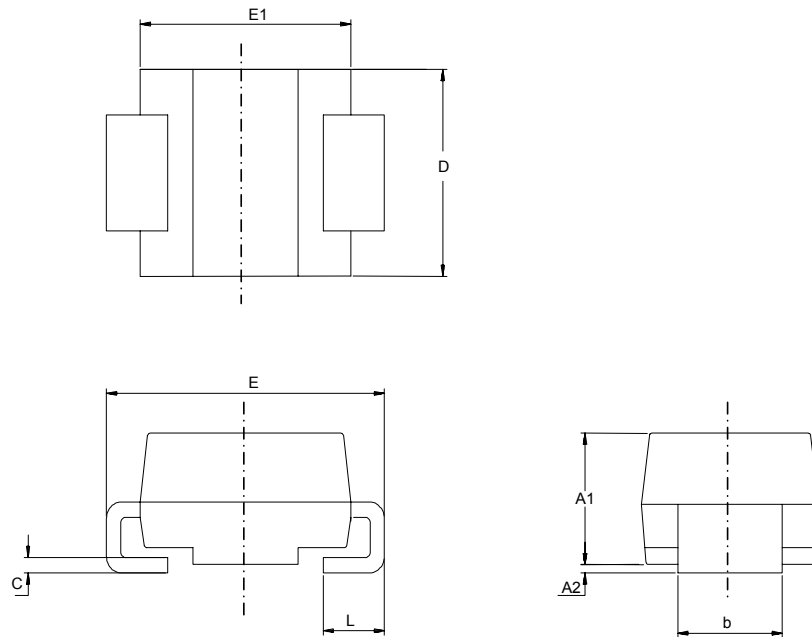
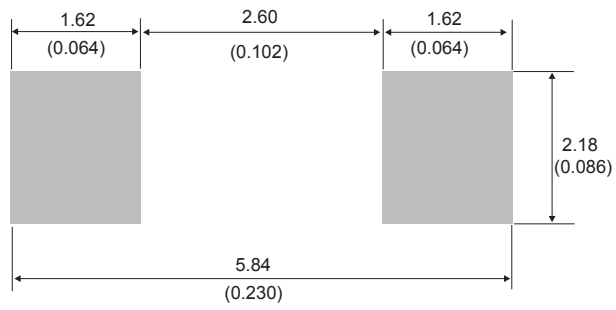

Table 5. SMB package mechanical data

Ref.	Dimensions			
	Millimeters		Inches (for reference only)	
	Min.	Max.	Min.	Max.
A1	1.90	2.45	0.074	0.097
A2	0.05	0.20	0.001	0.008
b	1.95	2.20	0.076	0.087
c	0.15	0.40	0.005	0.016
D	3.30	3.95	0.129	0.156
E	5.10	5.60	0.200	0.221
E1	4.05	4.60	0.159	0.182
L	0.75	1.50	0.029	0.060

Figure 18. SMB recommended footprint



2.3 SMC package information

- Epoxy meets UL94, V0

Figure 19. SMC package outline

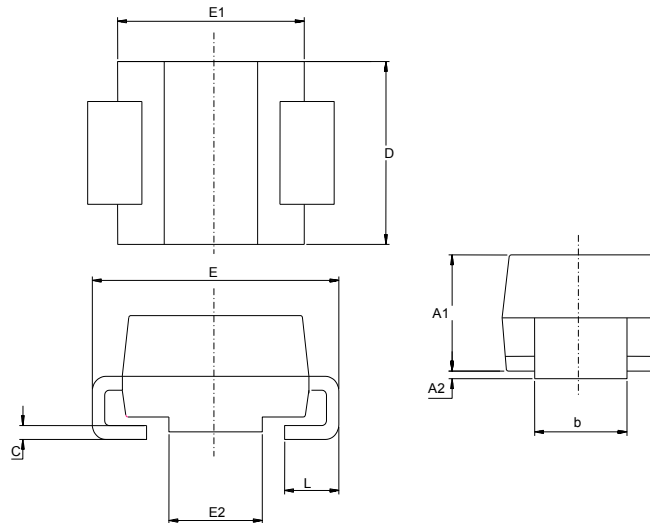
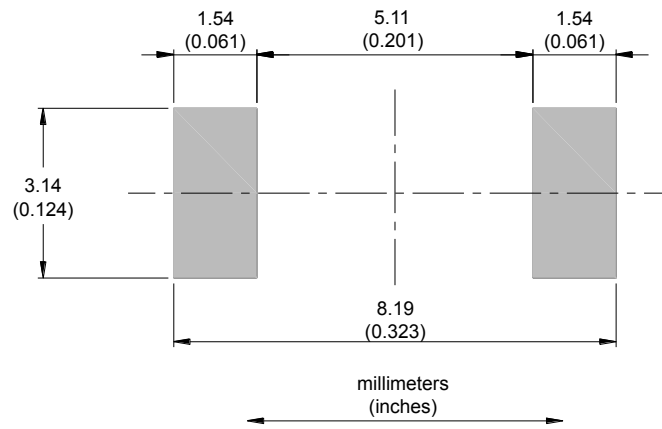

Table 6. SMC package mechanical data

Ref.	Dimensions			
	Millimeters		Inches (for reference only)	
	Min.	Max.	Min.	Max.
A1	1.90	2.45	0.0748	0.0965
A2	0.05	0.20	0.0020	0.0079
b	2.90	3.20	0.1142	0.1260
c	0.15	0.40	0.0059	0.0157
D	5.55	6.25	0.2185	0.2461
E	7.75	8.15	0.3051	0.3209
E1	6.60	7.15	0.2598	0.2815
E2	4.40	4.70	0.1732	0.1850
L	0.75	1.50	0.0295	0.0591

Figure 20. SMC recommended footprint



2.4 DO-201AD package information

- Epoxy meets UL 94, V0

Figure 21. DO-201AD package outline

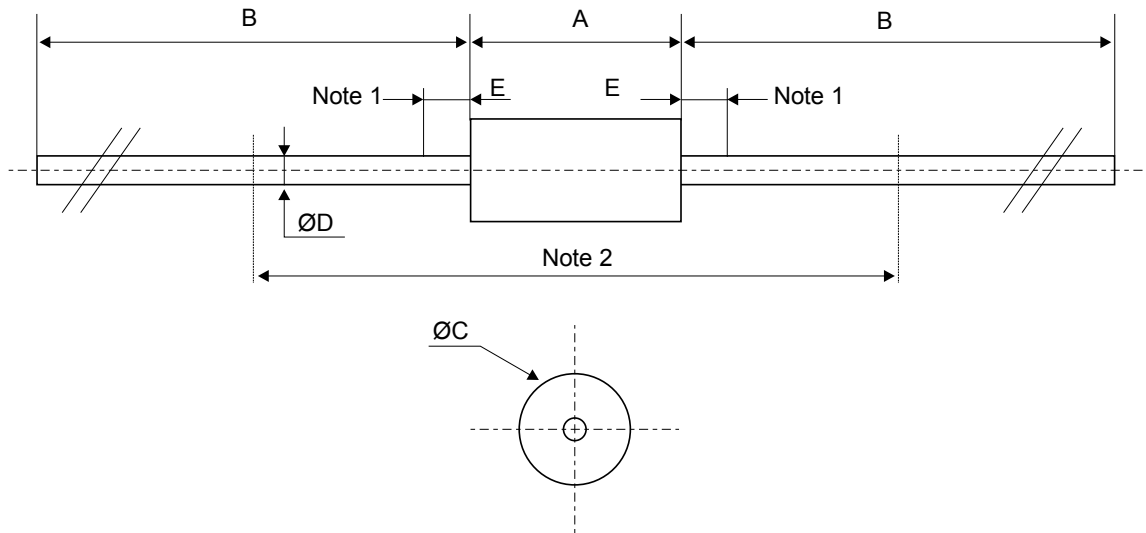

Table 7. DO-201AD package mechanical data

Ref.	Dimensions					
	Millimeters			Inches (for reference only)		
	Min.	Typ.	Max.	Min.	Typ.	Max.
A		-	9.50		-	0.374
B	25.40	-		1.000	-	
C		-	5.30		-	0.209
D ⁽¹⁾		-	1.30		-	0.051
E		-	1.25		-	0.049
Note 2 ⁽²⁾	15.00			0.590		

- The lead diameter *D* is not controlled over zone *E*
- The minimum length, which must stay straight between the right angles after bending, is 15 mm (0.59")

3 Ordering information

Table 8. Ordering information

Order code	Marking	Package	Weight	Base qty.	Delivery mode
STPS5L60UFN	B56	SMB Flat Notch	0.056 g	5000	Tape and reel
STPS5L60U	G56	SMB	0.107 g	2500	Tape and reel
STPS5L60RL	STPS5L60	DO-201AD	1.12 g	1900	Tape and reel
STPS5L60L	STPS5L60			600	Ammopack
STPS5L60S	S56	SMC	0.245 g	2500	Tape and reel

Revision history

Table 9. Document revision history

Date	Version	Changes
July-2003	2	Previous issue.
16-May-2008	3	Added ECOPACK statement. Added SMC package. Updated characteristic curves.
17-Jul-2015	4	Added SMB package information and reformatted to current standard.
31-Jan-2020	5	Added Section 2.1 SMB Flat Notch package information .

IMPORTANT NOTICE – PLEASE READ CAREFULLY

STMicroelectronics NV and its subsidiaries (“ST”) reserve the right to make changes, corrections, enhancements, modifications, and improvements to ST products and/or to this document at any time without notice. Purchasers should obtain the latest relevant information on ST products before placing orders. ST products are sold pursuant to ST’s terms and conditions of sale in place at the time of order acknowledgement.

Purchasers are solely responsible for the choice, selection, and use of ST products and ST assumes no liability for application assistance or the design of Purchasers’ products.

No license, express or implied, to any intellectual property right is granted by ST herein.

Resale of ST products with provisions different from the information set forth herein shall void any warranty granted by ST for such product.

ST and the ST logo are trademarks of ST. For additional information about ST trademarks, please refer to www.st.com/trademarks. All other product or service names are the property of their respective owners.

Information in this document supersedes and replaces information previously supplied in any prior versions of this document.

© 2020 STMicroelectronics – All rights reserved

Mouser Electronics

Authorized Distributor

Click to View Pricing, Inventory, Delivery & Lifecycle Information:

[STMicroelectronics:](#)

[STPS5L60](#) [STPS5L60S](#) [STPS5L60U](#)