

LQW18AN27NJ00#

“#” at the end indicates the package specification code.

Size Code 1608 (0603) in mm (in inch), Wound Type



< List of part numbers with package codes >

LQW18AN27NJ00B LQW18AN27NJ00D LQW18AN27NJ00J

Applications

Unsuitable Applications	Please be sure to read and comply with these "Precautions for use."
Specific Applications	Consumer equipment, Medical equipment [GHTF A/B/C] except for implant & surgery & auto injector, Industrial equipment except for transportation & facility & energy equipment Please refer to Our Website and specifications, etc. for information about the performance, functions, quality, management, and safety required for the above applications, and use Products after confirming the performance and reliability of the actual Product.
Recommended Applications	Consumer equipment

Appearance & Shape

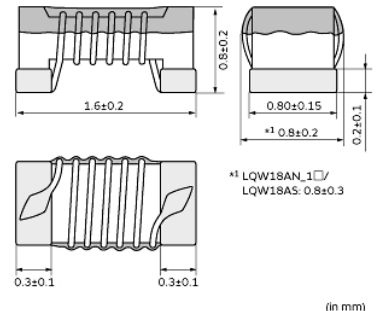
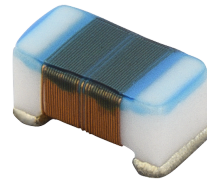

Attention

- 1.This datasheet is downloaded from the website of Murata Manufacturing Co., Ltd. Therefore, it's specifications are subject to change or our products in it may be discontinued without advance notice. Please check with our sales representatives or product engineers before ordering.
- 2.This datasheet has only typical specifications because there is no space for detailed specifications.
Therefore, please review our product specifications or consult the approval sheet for product specifications before ordering.

LQW18AN27NJ00#

“#” at the end indicates the package specification code.



References

Packaging	Specifications	Standard Packing Quantity
B	Bulk(Bag)	500
D	180mm Paper Tape	4000
J	330mm Paper Tape	10000

Mass (typ.)	
1 piece	0.003g

Attention

1.This datasheet is downloaded from the website of Murata Manufacturing Co., Ltd. Therefore, it's specifications are subject to change or our products in it may be discontinued without advance notice. Please check with our sales representatives or product engineers before ordering.

2.This datasheet has only typical specifications because there is no space for detailed specifications.

Therefore, please review our product specifications or consult the approval sheet for product specifications before ordering.

LQW18AN27NJ00#

“#” at the end indicates the package specification code.



Specifications

L size	1.6±0.2mm
W size	0.8±0.2mm
T size	0.8±0.2mm
Size code inch (mm)	0603 (1608)
Inductance	27nH±5%
Inductance Test Frequency	100MHz
Rated current (Itemp) (Based on Temperature rise)	440mA
Max. of DC resistance	0.21Ω
Operating Temperature Range(Self-temperature rise is not included)	-55°C to 125°C
Class of magnetic shield	Non-Shielded
Q(min.)	40
Q Test Frequency	250MHz
Self resonance frequency (min.)	3700MHz
Brand	Murata
Series	LQW18AN_00

Attention

1.This datasheet is downloaded from the website of Murata Manufacturing Co., Ltd. Therefore, it's specifications are subject to change or our products in it may be discontinued without advance notice. Please check with our sales representatives or product engineers before ordering.

2.This datasheet has only typical specifications because there is no space for detailed specifications.

Therefore, please review our product specifications or consult the approval sheet for product specifications before ordering.

LQW18AN27NJ00#

“#” at the end indicates the package specification code.



Characteristic Data

The charts below may show another part number which shares its characteristics.

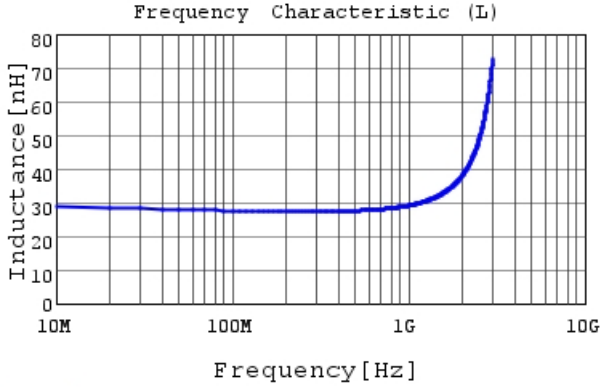

LQW18AN27NJ00 L

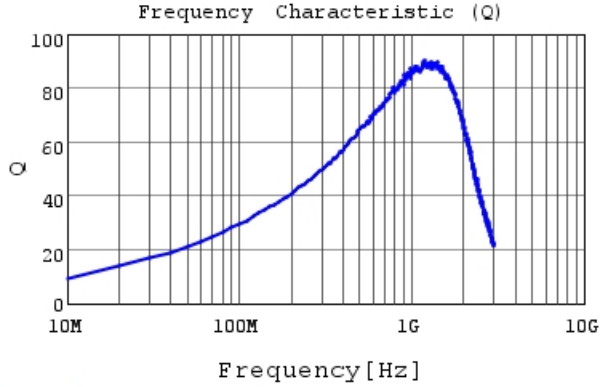

LQW18AN27NJ00 Q

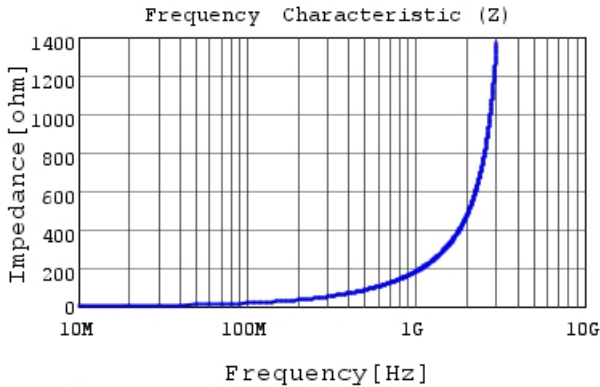

LQW18AN27NJ00 |Z|

Attention

- 1.This datasheet is downloaded from the website of Murata Manufacturing Co., Ltd. Therefore, it's specifications are subject to change or our products in it may be discontinued without advance notice. Please check with our sales representatives or product engineers before ordering.
- 2.This datasheet has only typical specifications because there is no space for detailed specifications.
Therefore, please review our product specifications or consult the approval sheet for product specifications before ordering.